

ESD workspaces

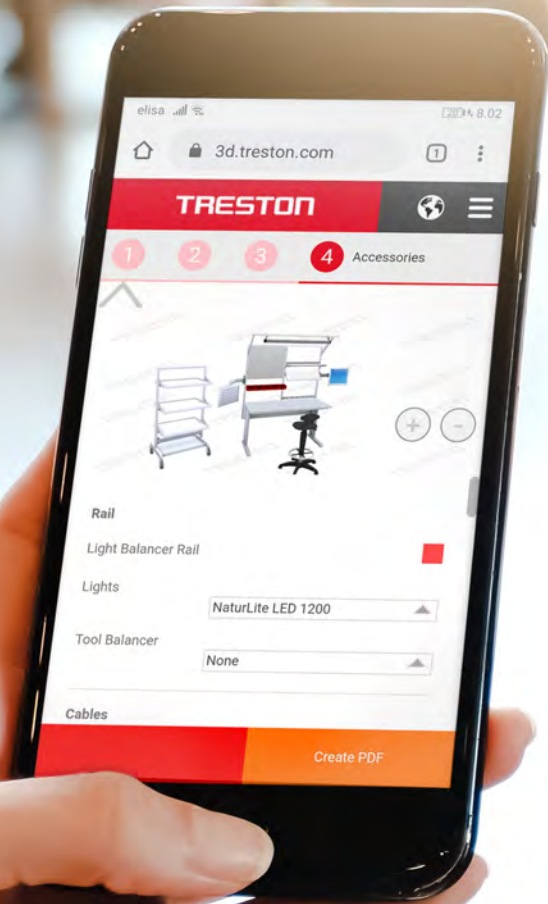

3d.treston.com



3D ONLINE CONFIGURATOR

Design your own workstation or trolley and view it in 3D



Workspaces for happier workfaces

ESD protection in technical and industrial workplaces 4

Workbenches

Concept - the most versatile workbench	14
WB - aesthetic and easily adaptable	18
TED - electric desk for industrial use	20
Quick Edge - extremely fast height adjustment	22
TP - ideal basic workbench	23
TPH - standard workbench with one shelf	25

Workbench accessories

ESD accessories for Concept TED, Quick Edge and TP	27
ESD accessories for WB	40
ESD accessories for TPH	43
Other ESD accessories	46
Non ESD certified accessories	47

Lighting 51

Chairs 55

Trolleys

Universal trolley WTR	58
Treston Industrial Multi trolley	59
Adjustable trolley TRTA	62
Reel holder trolley RRT	63
Mobile workstations	64
Trolleys for additional workspace	65
Bin and cabinet trolley	66

Drawer units

Light steel cabinet LMC	68
Drawer units 30 and 35	68
Drawer unit 45	69

Storage systems

FiFo Flow Rack	72
Shelving system	74
Industrial cabinets	74
Shelving cabinets	75
Small-parts storage cabinets	76
Spacemisers for small-parts storage cabinets	77
Storage bin cabinets	78
Spacemisers for storage bin cabinets	78
High density storage cabinets	79
ESD bins	80

Spare parts 81



TRESTON

WORKSPACES FOR HAPPIER WORKFACES

WORKSPACES FOR HAPPIER WORKFACES

There's no way around it. Sustainable long term business success in every industry is founded on empowered, motivated and healthy employees, and hyper adaptability to constant change.

The solution is simple.

A smart industrial workspace that adapts flexibly to the needs of the individual and the constant changes in the process. A next generation workstation and material flow solution that drives better business performance, environmental performance and personal performance by integrating and optimizing all work phases into a leaner, cleaner and greener process.

With decades of experience, in depth understanding of ergonomics in industrial environments, unmatched ESD competence and proven LEAN knowhow we at Treston are in a unique position to help our customers in keeping their business and people in good shape.

Workspaces for happier workfaces.

This is our aspiration. This is our promise. This is what Treston is all about.

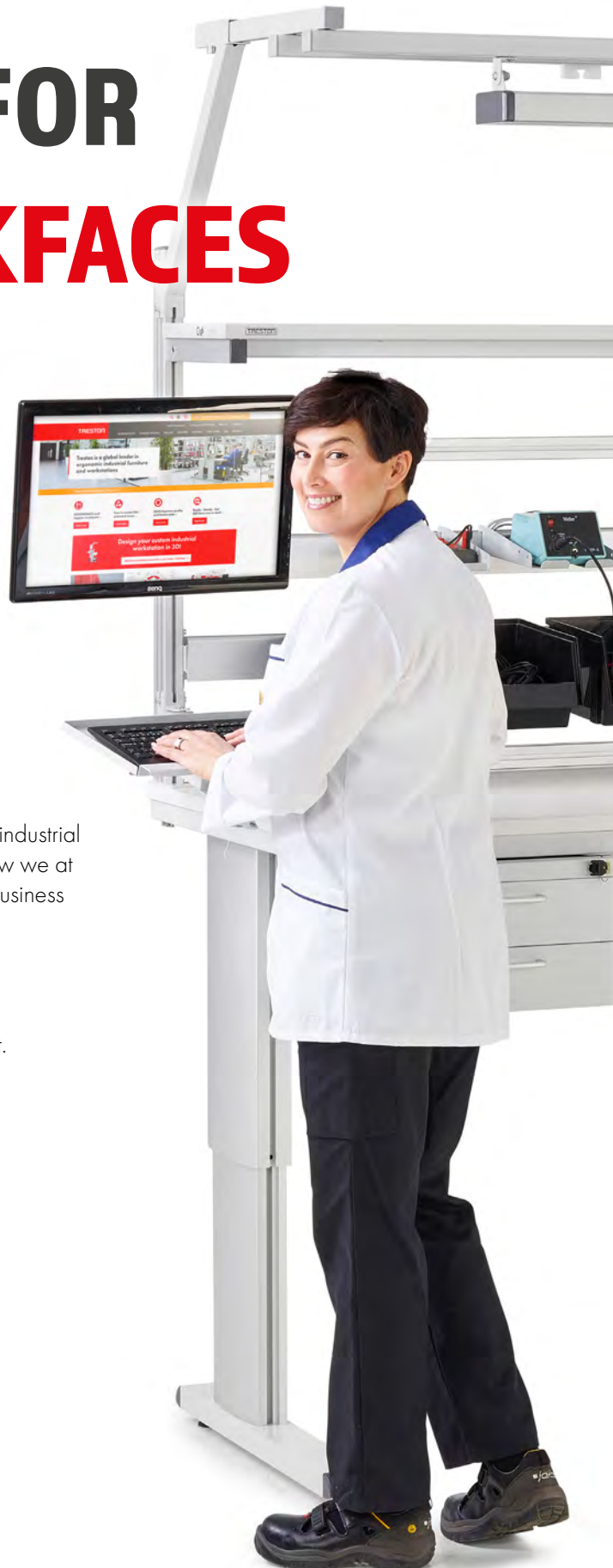

ESD protection guarantees a safe working environment

Particularly in the electronics industry, work is often carried out in an ESD protected area (EPA) that is protected from static discharge. To create and maintain an EPA one needs to pay special attention to furniture and personnel, which need to be grounded. Protection can involve earthing equipment and painting the frame of the workstation with semi-conductive paint.

We have extensive experience in developing, manufacturing and supplying ESD furnishings. All our workstations and related products are available with an electrically semi-conductive coat of paint and we supply furnishings, seats and earthing components for ESD-protected workstations. We also build complete production systems equipped with ESD-protection. Our ESD-protected products meet the requirements specified in the IEC 61340-5-1 standard.

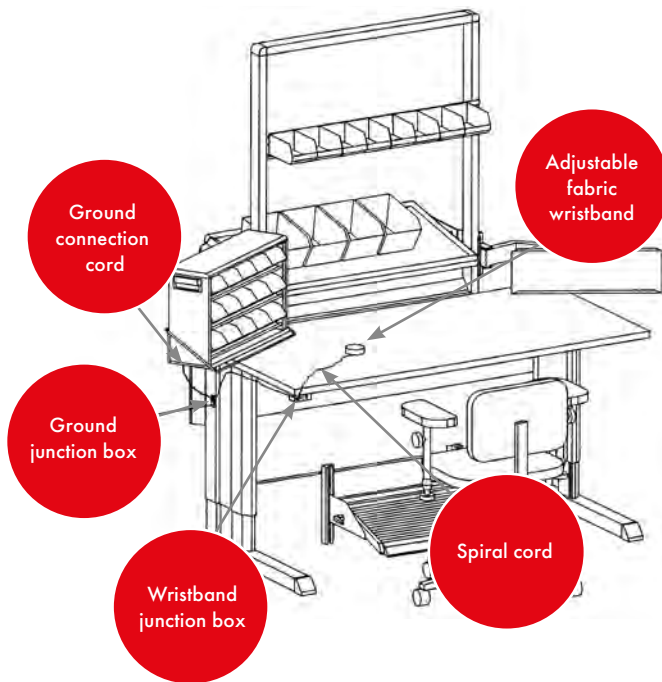

Static electricity

The abbreviation ESD stands for Electrostatic Discharge, a process that occurs between two objects of differing electric potential. Normally, electric charges are discharged slowly from objects' surfaces. If the difference in electric potential becomes too high, the electrical current accelerates resulting in a sudden current surge.

An ESD protected area is called an EPA. In an EPA, ESD protection must be observed in all materials, employees' clothing and air humidity. Employees in an EPA must also be earthed with protective resistance (1 Mohm) to an ESD earth.

Terms and explanations

ESD	Electrostatic discharge. Occurs when two electrically-charged objects come together and a charge is discharged. Could result in either immediate or latent damage to an electrical component
ESDS	Electrostatic discharge sensitive. A component that needs ESD protection.
EPA	ESD-protected area.
CONDUCTIVE MATERIAL	Conductor = material that permits electricity flow. Metals are often conductive, e.g. copper and aluminium.
INSULATING MATERIAL	Insulator = material that does not conduct electricity. The insulator can be electrostatically charged. Insulators can be plastic or wood, for example.
STANDARDS	IEC 61340-5-1: ESD standard widely used in Europe and ANSI S20.20 in the Americas. Both standards have a great number of similarities.

ESD - Electrostatic discharge

In ordinary movement a person creates static electricity. In these circumstances hand contact with a conductive material will discharge static from the body very rapidly. This is ESD = Electrostatic discharge. Static electricity has become a major problem in the electronics industry. Usually this passes unnoticed because our bodies do not feel discharges below 3000 volts. We may see ESD above 5000 volts as a spark.

The most sensitive components may be damaged by a charge of just 30 volts, and many standard components

are sensitive to charges of 100...200 volts. The presence of inherent ESD is not easy to detect. Product-related defects can often be latent and become active over time. An unbroken ESD safety chain is essential to guarantee the quality of the final product. An ESD-protected production chain is called an EPA (= ESD Protected Area). Employees must be able to implement the right policies in an ESD-protected work environment.

CHARGES GENERATED ON DAILY WORK ACTIVITIES

Walking across a carpet	1 500 – 35 000 volts
Walking over vinyl floor	250 – 12 000 volts
Working at a bench	700 – 6 000 volts
Picking up a plastic bag from bench	1 200 – 20 000 volts
Chair with polyurethane foam	400 - 3 000 volts

The lower the relative humidity the higher the voltage. The lowest values in the table usually apply when the relative humidity is 65-90%. During a cold winter day, the relative humidity in indoor spaces can be as low as 10 %.

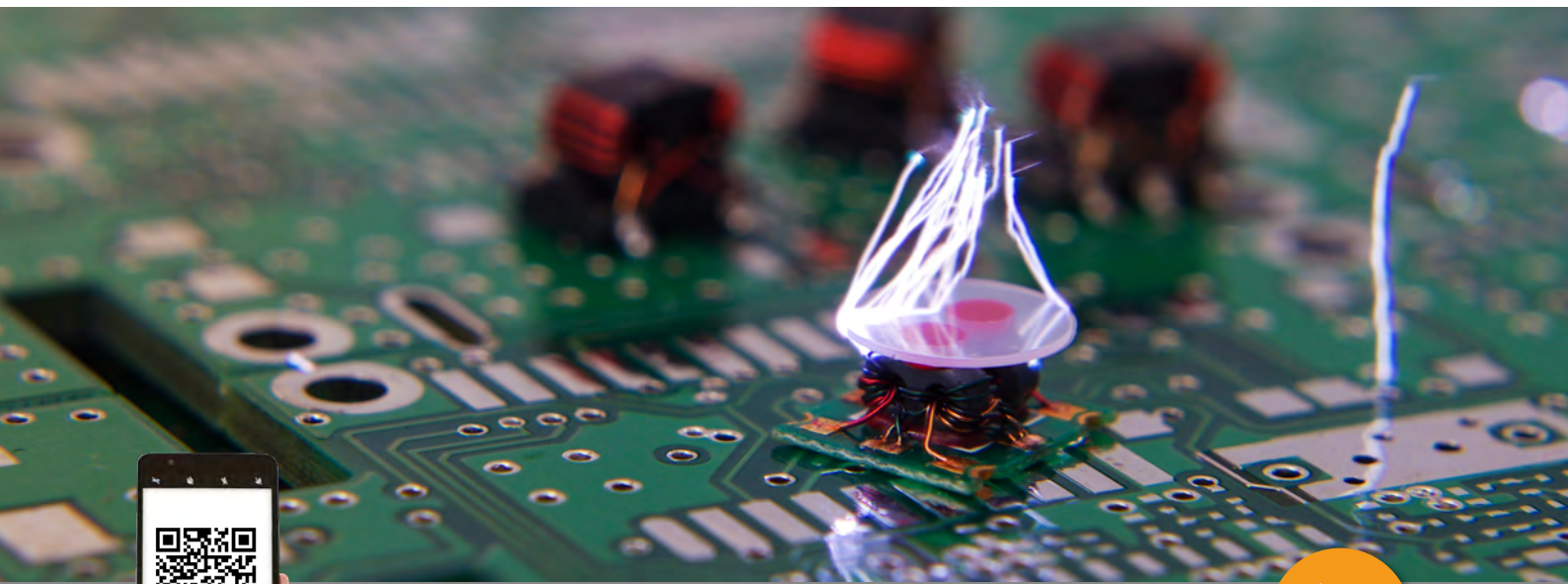

Watch this video: ESD workstation management
<https://vimeo.com/657013937>

Investing in an EPA is important

There are two types of ESD damage in industrial and technical environments. Firstly, a fatal defect that is usually easily detected during assembly or handling, or at least through careful testing. Such products are usually not delivered to customers. Secondly, another type of ESD damage is latent damage. This is difficult to detect with

bear eyes and the product may pass all tests and function normally for some time. However, latent damage affects the performance and durability of the product and often results in poor product quality.

Static charge management of a working area:

- ESD-protected workstations. Attention paid to ESD safe storing, moving and packing.
- Personnel protected with shoes, wrist straps and other needed accessories
- Staff training, work instructions and quality control
- Cleanliness of ESD-protected equipment. Dust and dirt insulate.
- Commitment to continuous improvement in static electricity management

Example of an ESD-protected area (EPA)

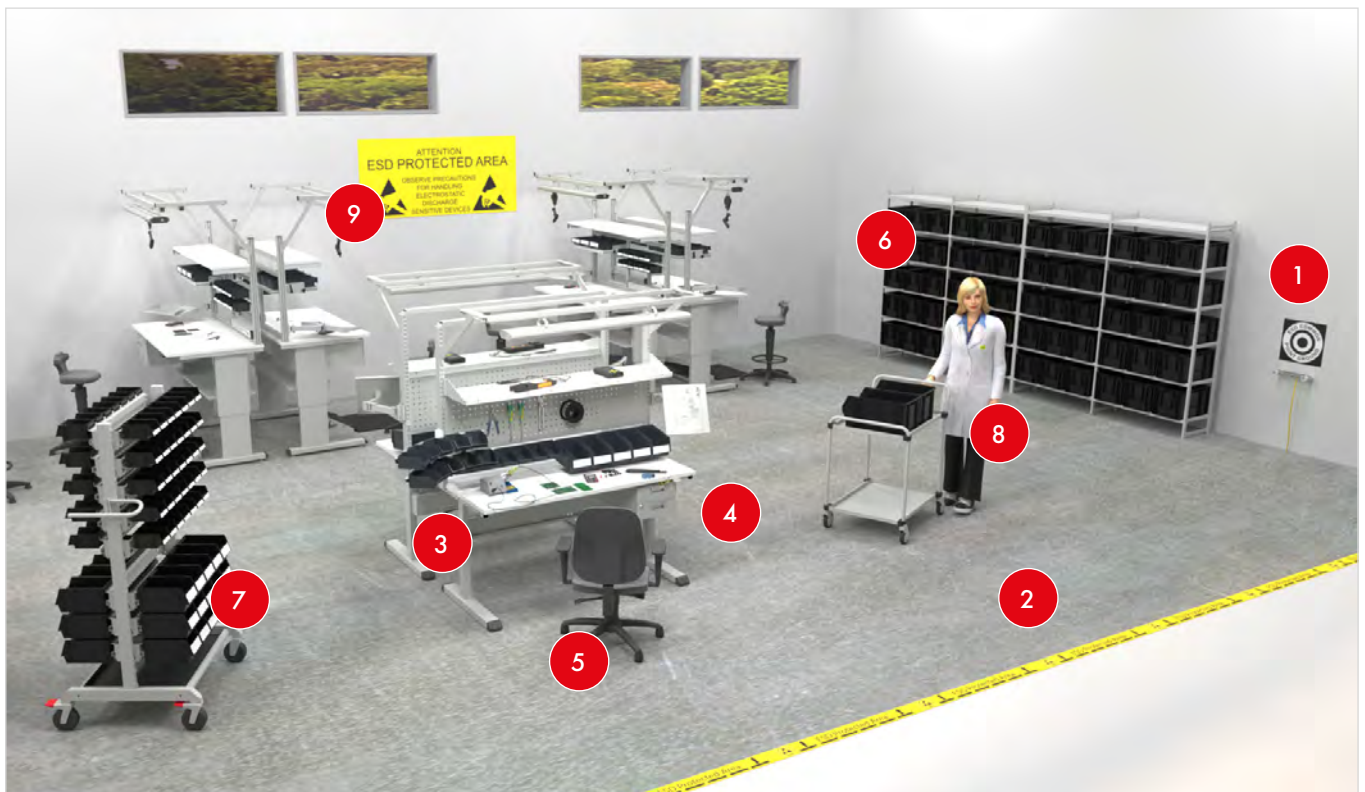

1. Common point ground
2. ESD floor
3. Semi-conductive table

4. Wrist strap + earth bounding point
5. Chair with ESD castors
6. Semi-conductive ESD shelf

7. Trolley with ESD castors
8. ESD garments (e.g. jacket and shoes)
9. EPA sign



6-Point checklist for creating and maintaining an EPA

1	CONTROL PLAN Includes e.g. component/product sensitivity levels, ESD protection level, daily routines and maintenance procedures.
2	FLOORING Grounded ESD floor or mat enables convenient usage of trolleys and chairs in EPA.
3	FURNITURE All furniture in EPA needs to be grounded.
4	PERSONNEL Wrist strap is the most efficient way to ground people working on EPA.
5	STORING, MOVING AND PACKING Store ESDS components in their original packages and minimise the transportation and movements.
6	CLEANING AND TESTING Regular cleaning with ESD detergent in EPA maintains the ESD protection.

ESD materials

<p>Semi-conductive laminate level</p> <ul style="list-style-type: none"> • Grounding resistance $10^6 - 10^8 \Omega$ • Surface resistance $10^6 - 10^9 \Omega$ • Withstands the heat of the soldering iron, most acids and bases 	<p>Semi-conductive painted steel parts</p> <ul style="list-style-type: none"> • Surface resistance $10^5 - 10^9 \Omega$
<p>Semi-conductive Polypropylene = PP</p> <ul style="list-style-type: none"> • Surface resistance $10^3 - 10^6 \Omega$ • Throughput $10^3 - 10^6 \Omega /$ • Temperature resistance from $-20^\circ / +70^\circ \text{ C}$ 	<p>Semi-conductive polystyrene = PS</p> <ul style="list-style-type: none"> • Surface resistance $10^3 - 10^6 \Omega$ • Throughput $10^3 - 10^6 \Omega$ • Temperature resistance from $-40^\circ / +55^\circ \text{ C}$

The ESD control plan

The ESD control plan determines how valuable and sensitive components and parts are protected from ESD damage, to set their own ESD limits, if necessary, and to establish a testing schedule for ESD materials. The ESD monitoring plan is the starting point for static electricity management and is one of the issues defined by IEC 61340-5-1.

The ESD Standard provides certain thresholds, and with your control plan you can set the level you want above or below the standard, depending on how sensitive your components are and what your needs are. The ESD control plan will usually also include information about the selected grounding system and method. The control plan shall also describe ESD products such as desks and trolleys, as well as maintenance, servicing and cleaning measures. An ESD control plan is a written plan of how components are handled during storage, transfer and packaging. Also note that employees must be well trained and informed about the ESD control plan and how it is implemented at your workplace. Everyone needs to know why the plan has been made, what it contains and how the ESD Protected Area (EPA) should work. Everyone needs to understand the importance of static electricity management and its implications for product quality, cost, and, ultimately, customer satisfaction. It is a good idea to make the ESD control plan part of your company's quality system so that everyone in your company understands its importance.

Setting up an ESD environment is simple and straightforward. An ESD-protected area can be small, for example, one workbench, or it can be large, with hundreds of workbenches. However, both areas need the same procedures, only the scale is different. Everything starts with the ESD control plan. Then you just need to roll up your sleeves and start implementing the plan, beginning with the floor and the common point ground, moving to ergonomic and ESD-protected furniture, personnel and, finally, cleaning and maintenance with measurements. If possible, it is a good idea to optimize the EPA layout so that the movement of sensitive components from bench to bench is minimized. Then you are ready to work on any type of ESD sensitive components without any problems.

No matter whether you are a component producer, electronics manufacturer or only occasionally work on sensitive electronic components, it is important to have ESD protection in place. Investing in ESD protection usually pays back in terms of both money and brand. If your products are long lasting and reliable they are usually also appreciated by your customer.



Colour codes

All the steel parts are light grey RAL 7035 and have a semi-conductive paint film. The semi-conductive powder coating we use is based on epoxy and polyester resin, which at elevated temperatures melts, cures and forms a semi-conductive paint film. This powder coating is developed especially for the ESD-protected areas (EPA). In addition, the paint film has excellent mechanical properties, i.e. abrasion and impact resistance and elasticity. It is not scratched easily and withstands action by chemicals, greases and solvents.

The products with colour code 49 (RAL 7035) are entirely ESD-protected: all the steel parts have a semi-conductive

paint film, castors, mats and bench tops are all made of semi-conductive materials. Please note that the semi-conductive powder coating RAL 7035 has a slightly darker shade of colour than the given RAL code.



The colour code is included in those product codes that are formed with numbers.

It is either at the end, following the hyphen (e.g. 860 804-49), or in the middle (e.g. C 334 49 000).



Our standards comply with the highest certification requirements



<p>Quality certification</p> <p>ISO 9001 : 2015</p>	<p>ESD-approval certification</p> <p>Our ESD products fulfill the basic requirements of IEC 61340-5-1.</p>	<p>Cleanroom Suitability of Treston Concept and WB Motorized Workstations</p> <p>ISO 14644-1, class 7</p>
--	---	--



<p>Cleanroom Suitability of Chair Treston Ergo C20PU-ESD</p> <p>ISO 14644-1, class 7</p>	<p>ESD certification</p> <p>Treston WB and Concept workstations fulfill the basic requirements of IEC 61340-5-1</p>	<p>ESD certification</p> <p>Treston shelf, stacking, storage and picking bins and storage cabinets fulfill the basic requirements of IEC61340-5-1.</p>
---	--	---

To obtain a copy of our certificates, please contact info@treston.com.

TRESTON WARRANTY PERIOD



The guarantee period for Treston™ products is 10 years from the date of delivery with some exceptions.

For plastic bins guarantee is 5 years. The warranty period for worksurfaces, electric components, saddle chairs, lights, and normal wear and tear items such as castors, slides and roll profiles is 2 years. For trading products and components as well as custom-made articles we guarantee 2-year warranty unless otherwise agreed.



Workbenches

Concept workbench, page 14

- Multiple bench variations with advanced ergonomic features
- Perfectly suitable for assembly, quality control or packing environments
- Highly adaptable to various applications and to the needs of the user
- Superior range of accessories, easily reconfigured
- Excellent stability, suitable for heavy loads up to 500 kg



WB workbench, page 18

- Aesthetic, ergonomic and easily adaptable to a large variety of tasks and environments
- Designed for the needs of R&D, electronics assembly and testing
- Extensive range of accessories to meet any need. Various layout possibilities from back-to-back to corner solutions
- Maximum load capacity 300 kg



TED electric desk, page 20

- TED Electric Desk comes with quick, silent and wide height adjustment
- This ergonomic sit-stand desk perfectly suits light-duty assembly work, packing applications, R&D and industrial offices
- The desk can be customized with accessories which further enhance ergonomics, free desk space and provide order
- The table withstands load of 200 kg



Quick Edge workstation, page 22

- The quickest height adjustment on the market - no electricity needed
- Can be customised for various operating environments
- Multiple accessories available: swivel arms for tool holders and screens, LED lights, shelves with dividers for cartons
- Maximum load capacity 100 kg



TP workbench, page 23

- Standard and cost-effective workbench
- Suitable for a wide range of tasks and environments
- Superior range of accessories, easily reconfigured
- Steel frame with loading capacity up to 300 kg



TPH workbench, page 25

- Standard and cost-effective workbench with one shelf
- Suitable for a wide range of tasks and environments
- Essential range of accessories for basic needs
- Steel frame with loading capacity up to 300 kg



Concept - the most versatile workbench

- Select the bench frame and the height adjustment method: allen key, hand crank or motor.
- Select a bench top to suit the frame.

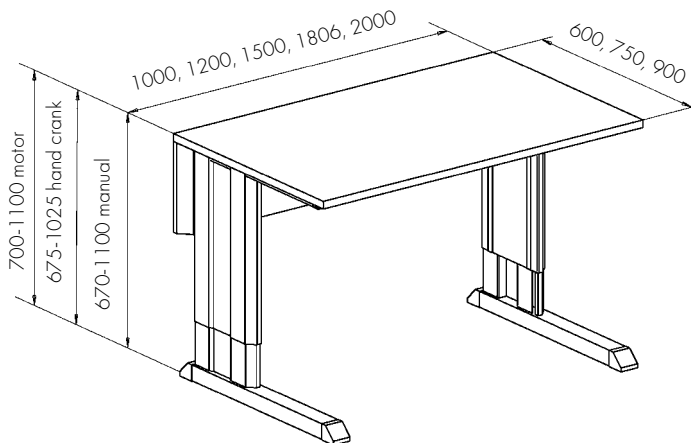

Concept workbench frame

Workbench frame size W x D mm	Bench frame, allen key adjustable Code ESD	Bench frame max load kg	Bench frame, hand crank adjustable Code ESD	Bench frame max load kg	Bench frame, motor adjustable Code ESD	Bench frame max load kg
1000 x 600	100 49 015P	500	101 49 015	200	103 49 015P	400
1000 x 750	100 49 030P	500	101 49 030	200	103 49 030P	400
1000 x 900	100 49 062P	500	101 49 062	200	103 49 062P	400
1200 x 600	100 49 016P	500	101 49 016	200	103 49 016P	400
1200 x 750	100 49 031P	500	101 49 031	200	103 49 031P	400
1200 x 900	100 49 063P	500	101 49 063	200	103 49 063P	400
1500 x 600	100 49 017P	500	101 49 017	200	103 49 017P	400
1500 x 750	100 49 032P	500	101 49 032	200	103 49 032P	400
1500 x 900	100 49 064P	500	101 49 064	200	103 49 064P	400
1800 x 600	100 49 018P	500	101 49 018	200	103 49 018P	400
1800 x 750	100 49 033P	500	101 49 033	200	103 49 033P	400
1800 x 900	100 49 065P	500	101 49 065	200	103 49 065P	400
2000 x 600	100 49 019P	500			103 49 019P	400
2000 x 750	100 49 034P	500			103 49 034P	400
2000 x 900	100 49 066P	500			103 49 066P	400
Bench height steplessly adjustable	670 - 1100 mm		675 - 1025 mm		700 - 1100 mm Height adjustment speed 13 mm / second	

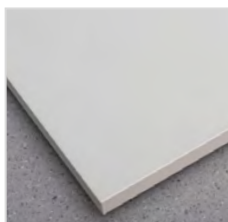

ESD bench top

- Light grey laminate surface
- Grey edging
- Thickness 25 mm
- Semi-conductive (ESD)



The Concept bench can be equipped with castors!

Castor set Ø100, Code ESD 860 429-00. Load capacity with castors 300 kg. Always adjust the bench with castors to the lowest position when the bench is moved.

Concept bench tops

Size W x D mm	Code ESD
1000 x 600	TT10060-ESD
1000 x 750	TT10075-ESD
1000 x 900	TT10090-ESD
1200 x 600	TT12060-ESD
1200 x 750	TT12075-ESD
1230 x 750	TT12375-ESD
1200 x 900	TT12090-ESD
1230 x 900	TT12390-ESD
1500 x 600	TT15060-ESD
1500 x 750	TT15075-ESD
1530 x 750	TT15375-ESD
1500 x 900	TT15090-ESD
1530 x 900	TT15390-ESD
1806 x 600	TT18060-ESD
1806 x 750	TT18075-ESD
1836 x 750	TT18375-ESD
1806 x 900	TT18090-ESD
1836 x 900	TT18390-ESD
2000 x 600	TT20060-ESD
2000 x 750	TT20075-ESD
2000 x 900	TT20090-ESD

Concept workbench examples

Concept ESD workstation 1

Qty	Name	Size mm	Code ESD
1	Motor adjustable bench frame	1500 x 750	103 49 032P
1	Bench top ESD	1500 x 750	TT15075-ESD
2	Cable duct	M750	860 044-49
1	Upright module, 1359 mm	2 x M750	UTM2X750M-49
1	Light/balancer rail	2 x M750	918 49 006P
1	Steel shelf	M750 x 300	836 028-49
1	Perforated panel	M750 x 389	861 511-49
1	Rotating tool panel frame with a double arm	513 x 320	880 865-49
1	Perforated panel for rotating tool frame	M500	860 951-49
1	Bin rail	M750	859 151-49
7	Stacking bin ESD	105 x 165 x 75	1015-4ESD
1	LCD screen holder with a double arm		930 49 002P
1	Power rail	M750	TPR7-001
1	Treston NaturLite LED	1200	TNL1200



Concept ESD workstation 2

Qty	Name	Size mm	Code ESD
1	Allen key adjustable bench frame	1500 x 750	100 49 032P
1	Bench top ESD	1500 x 750	TT15075-ESD
1	Upright module, 1359 mm	2 x M750	UTM2X750M-49
1	Light/balancer rail	2 x M750	918 49 006P
1	Treston NaturLite LED	1200	TNL1200
1	Perforated panel	M750 x 612	861 512-49
1	Power rail	M750	TPR7-001
2	Steel shelf	M750 x 300	836 028-49
1	Drawer unit 30/15	300 x 454 x 150	859 330-49
1	Fastening set		890 653-49



Concept ESD workstation 3

Qty	Name	Size mm	Code ESD
1	Motor adjustable bench frame	1500 x 750	103 49 032P
1	Bench top ESD	1500 x 750	TT15075-ESD
1	Upright module, 1359 mm	2 x M750	UTM2X750M-49
1	Light/balancer rail	2 x M750	918 49 006
1	Treston NaturLite LED	1200	TNL1200
1	Perforated panel	M750 x 389	861 511-49
1	Steel shelf	M750 x 300	836 028-49
2	Bin rail	M750	859 151-49
14	Stacking bin ESD	105 x 165 x 75	1015-4ESD
1	Curved bin rail with a double arm	770 x 54	929 49 002P
1	Extension for curved bin rail	770 x 54	860 911-49
10	Picking bin ESD	99 x 160 x 70	30-1L-4ESD



Concept ESD workstation 4

Qty	Name	Size mm	Code ESD
1	Allen key adjustable bench frame	1800 x 750	100 49 033P
1	ESD bench top	1806 x 750	TT18075-ESD
1	Upright module, 1359 mm	2 x M900	UTM2X900M-49
1	Light/balancer rail	2 x M900	918 49 008P
1	Treston NaturLite LED	1200	TNL1200
4	Steel shelf	M900 x 300	852 283-49
2	Power rail	M900	TPR9-001
1	Accessory bar	1800	860 089-49
1	Footrest, bar	550 x 350	860 136-49

Concept ESD workstation 5

Qty	Name	Size	Code ESD
1	Allen key adjustable bench frame	1800 x 750	100 49 033P
1	ESD bench top	1806 x 750	TT18075-ESD
1	Upright module, 1359 mm	2 x M900	UTM2X900M-49
2	Cable duct	M900	860 045-49
1	Light/balancer rail	2 x M900	918 49 008P
1	Treston NaturLite LED	1200	TNL1200
2	Steel shelf	M900 x 400	852 769-49
2	Power rail	M900	TPR9-001
1	LCD screen holder with double arm		930 49 002P
1	Accessory bar	1800	860 089-49
1	Footrest, bar	550 x 350	860 136-49
1	CPU holder for Concept table	180-225 x 450 x 50	860 552-49
1	Drawer unit 30/15	300 x 454 x 150	859 330-49
1	Fastening set		890 653-49

Concept ESD workstation 6

Qty	Name	Size mm	Code ESD
1	Allen key adjustable bench frame	1500 x 750	100 49 032P
1	ESD bench top	1500 x 750	TT15075-ESD
1	Upright tube module, 1359 mm	2 x M750	UTM2X750M-49
1	Light and balancer rail	2 x M750	918 49 006P
1	Steel shelf	M750 x 300	836 028-49
1	Steel shelf	M750 x 400	852 770-49
1	Divider pair	385 x 190	010 005-49
1	Bin rail	M750	859 151-49
1	LCD screen holder with a double arm		930 49 002P
1	Keyboard tray for LCD holder	480 x 260	860 941-49
1	Drawer unit 30/22 with an electronic code lock	300 x 454 x 220	720 010-49
1	Fastening set		890 653-49
1	Accessory bar	1500	860 088-49
1	CPU holder for accessory bar	150 x 500 x 85	860 551-49
1	Treston NaturLite LED	1200	TNL1200
2	Perforated panel	M750 x 1003	861 514-49



Concept extension benches

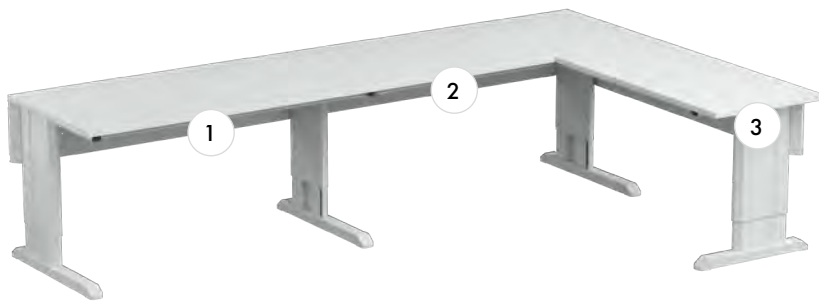

- 1. Workbench frame,
- 2. Extension bench frame
- 3. Corner bench frame

Concept extension bench frame (right)

Name	Size W x D mm	Max load kg	Code ESD
Extension bench frame	1500 x 600	250	112 49 001P
Extension bench frame	1500 x 750	250	112 49 002P
Extension bench frame	1800 x 750	250	112 49 003P
Extension bench frame	1500 x 900	250	112 49 007P
Extension bench frame	1800 x 900	250	112 49 008P

Concept corner bench frame (right)

Name	Size W x D mm	Max load kg	Code ESD
Corner bench frame for allen key adjustable bench 600 mm deep	1000 x 600	250	111 49 001P
Corner bench frame for allen key adjustable bench 750 mm deep	1200 x 600	250	111 49 002P

Concept extension bench frame (left)

Name	Size W x D mm	Max load kg	Code ESD
Extension bench frame	1500 x 600	250	112 49 004P
Extension bench frame	1500 x 750	250	112 49 005P
Extension bench frame	1800 x 750	250	112 49 006P
Extension bench frame	1500 x 900	250	112 49 009P
Extension bench frame	1800 x 900	250	112 49 010P

Concept corner bench frame (left)

Name	Size W x D mm	Max load kg	Code ESD
Corner bench frame for allen key adjustable bench 600 mm deep	1000 x 600	250	111 49 003P
Corner bench frame for allen key adjustable bench 750 mm deep	1200 x 600	250	111 49 004P

Battery set for Concept motor adjustable frames and TED electric desks

The smaller sized Concept and TED workbenches equipped with castors, electric height adjustment, and battery set are an excellent option for workspaces where you need a compact size, easily height adjustable, and mobile work surface. You get all the ergonomic benefits of easy, electric height adjustment, and freedom of mobility with the battery set – no need to worry if the power cables are long enough for moving the work surface around the workspace.

Name	Code
Battery set	BSC001

Suitable for Concept motor adjustable frames and TED electric desks. Battery set sold only to EU countries.

Note: Battery set is not ESD certified.



All non ESD certified accessories are EPA –compatible when their combination of the potential charge level and physical distance to the ESDS –related parts is managed by ESD standard IEC 61340-5-1



Watch this animation showcasing the versatile usage options

<https://vimeo.com/216622645>



WB - aesthetic and easily adaptable

- Select the height adjustment method: allen key, electric or crank.
- Stepless height adjustment between 700-1100 mm.

WB allen key adjustable bench

Bench size W x D mm	Max load kg	Code ESD
1073 x 800	300	WB811 ESD
1500 x 800	300	WB815 ESD
1800 x 800	300	WB818 ESD

We recommend using the cable tidy WBCT with WB Allen-key adjustable benches (page 41).

WB electric adjustable bench

Bench size W x D mm	Max load kg	Code ESD
1073 x 800	300	WB811 EL ESD
1500 x 800	300	WB 815 EL ESD
1800 x 800	300	WB818 EL ESD

Height adjustment speed 20 mm/ second.

Cable tidy as standard.

WB crank adjustable bench

Bench size W x D mm	Max load kg	Code ESD
1073 x 800	200	WB811 C ESD
1500 x 800	200	WB815 C ESD
1800 x 800	200	WB818 C ESD

Cable tidy as standard.



WB electric adjustable bench has a desk panel with memory function



ESD bench top

- Light grey laminate surface
- Grey edging
- Thickness 25 mm
- Semi-conductive (ESD)

The WB bench can be equipped with castors!

Castor set Ø100, Code ESD LCS100 ESD

Load capacity with castors is the same as the bench loading capacity with adjustable screws. We recommend using the cable tidy WBCT with WB Allen-key adjustable benches. Always adjust the bench with castors to the lowest position when the bench is moved.

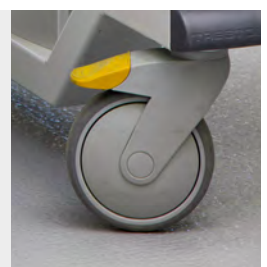

WB workbench examples

WB ESD workstation 1

Qty	Name	Size mm	Code ESD
1	WB workbench EL ESD	1500 x 800	WB815 EL ESD
1	Accessory frame	690 x 500 + 690 x 500	AKK150
1	Upright profile	1489 x 900	AL2X150W
1	Support bracket		HSB150
1	Treston NaturLite LED	1200	TNL1200
1	Shelf	1500 x 310	ALH150 ESD
1	Perforated panel	668 x 500	ARL70
1	Bin profile	685	BP70
1	Light steel cabinet, 2 x 100	370 x 460 x 245	LMC02 ESD
1	Cover for LMC		LMCK2



WB ESD workstation 2

Qty	Name	Size mm	Code ESD
1	WB electric adjustable bench	1037 x 800	WB811 EL ESD
1	Castor set	Ø 100	LCS100 ESD
1	Upright profile	1063 x 900	AL2X110W
1	LCD bracket		MH
1	Bin profile	985	BP100 ESD
1	Auxiliary steel shelf A5	159 x 210	ASSA5
2	Treston NaturLite Led Wing 500	500	TNL500W
1	Light steel cabinet	370 x 460 x 135	LMC01 ESD
1	Cover		LMCK2



WB ESD workstation

Qty	Name	Size mm	Code ESD
1	WB electric adjustable bench	1800 x 800	WB818 EL ESD
1	Earthing box ESD		J6603
1	Upright profile	1789 x 900	AL2X180W
1	Support bracket	1800	HSB180
1	Treston NaturLite Led	1200	TNL1200
1	Shelf ALH ESD	1800 x 310	ALH180 ESD
1	Accessory frame AKK ESD	690 x 500 + 990 x 500	AKK180
1	Perforated panel ESD	668 x 500	ARL70
2	Bin profile ESD	985	BP100 ESD
2	Auxiliary steel shelf A5	159 x 210	ASSA5
1	Swivel arm with tray ESD	460 x 210	AKV400 ESD
1	LCD swivel arm		MA
1	Light steel cabinet ESD	370 x 460 x 245	LMC02 ESD
1	Cover		LMCK2
1	Magnifying lamp Wave LED ESD		TWL ESD



Watch this animation showcasing the versatile usage options

<https://vimeo.com/219470050>



TED - electric desk for industrial use

- TED desk consists of the frame and the bench top.
- Quick, silent and wide height adjustment 630-1270 mm (range 64 cm)



TED Electric Desk

Bench size W x D mm	Module	Max load kg	Code ESD
900 x 800	M750	200	TED809-49
1100 x 800	M900	200	TED811-49
1500 x 800	M1350	200	TED815-49
1800 x 800	M1500	200	TED818-49

Height adjustment speed 22 mm / second



TED desk can be equipped with castors!

Castor set Ø100 ESD Code LCS100 ESD

Always adjust the bench with castors to the lowest position when the bench is moved.



ESD bench top

- Light grey laminate surface
- Grey edging
- Thickness 25 mm
- Semi-conductive (ESD)

Upright Tube Pair with a flange

Size W x D x H mm	Code ESD
70 x 100 x 418	TTP400-49
70 x 100 x 793	TTP790-49
70 x 100 x 997	TTP990-49

Treston upright tubes enable TED electric desk to be accessorised in many ways. Fitted on worktop with screws.



Lower shelf for TED desk

Size W x D mm	Suitable for	Max load kg	Code ESD
465 x 400	All TED benches	60	LST500-49
715 x 400	TED811, TED,815, TED818	60	LST750-49
865 x 400	TED815, TED818	60	LST900-49
965 x 400	TED815, TED818	60	LST1000-49
1165 x 400	TED818	60	LST1200-49
1315 x 400	TED818	60	LST1350-49

Divider hoops set (4 pcs) 400 x 400 PDH400-49

Includes back lip. Fitted under worktop with screws. The lower shelf can also be equipped with divider hoops.



TED desk examples

TED ESD workstation 1

Qty	Name	Size mm	Code ESD
1	Treston Electric Desk	1500 x 800	TED815-49
1	Upright Tube Pair with a flange	400	TTP400-49
2	Treston Display Bracket for light duty		TDB-49
1	Drawer unit ESD 30/22		859 340-49
1	Drawer unit 30 fastening set for TED		855 057-49
1	Bottle holder ESD for upright tube	Ø100	859 063-49



TED ESD workstation 2

Qty	Name	Size mm	Code ESD
1	Treston Electric Desk	1100 x 800	TED811-49
1	Upright Tube Pair with a flange	790	TTP790-49
1	Perforated back panel	M900	861 516-49
1	LCD monitor holder for perforated panel		890 715-49
2	Treston NaturLite Led Wing 500		TNL500W
2	Auxiliary steel shelf for perforated panel	159 x 210	ASSA5PP
1	Bottle holder ESD for upright tube	Ø100	859 063-49
1	Laptop/printer shelf ESD	365 x 365	930 49 001P
1	Cable clip set for upright tubes		CC5
1	Power rail	836	TPR9-010



TED ESD workstation 3

Qty	Name	Size mm	Code ESD
1	Treston Electric Desk ESD	1500 x 800	TED815-49
1	Upright Tube Pair with a flange	790	TTP790-49
1	Light and balancer rail ESD		918 49 011P
1	Treston IntoLite Led	850	TIL850
1	Perforated back panel	M1350	861 521-49
1	Treston Display Bracket for light duty		TDB-49
1	Curved bin rail ESD with arm	770 x 54	929 49 002P
1	Steel shelf ESD M1350	1340 x 300	860 787-49
1	Aluminium bin rail M1350		BP1350C
2	Auxiliary steel shelf	159 x 210	ASSA5
1	Magnifying lamp Wave LED ESD		TWL ESD
1	Drawer unit ESD 30/15		859 330-49
1	Drawer unit 30 fastening set for TED		855 057-49
1	Power rail	836	TPR9-010



Watch the 2 min animation showcasing the features
<https://vimeo.com/513555408>



Treston Quick Edge workstation - extremely fast height adjustment

- Quick Edge workstation consists of the frame, the bench top and upright profiles.
- Equip with M1200 wide accessories, swivel arms or printer platforms.
- Quick Edge workstation can be used in EPAs with grounding set TQE-ESD.

Quick Edge workstation

Size W x D mm	Module	Max load kg	Code
1200 x 700	M1200	100*	TQEW712-41

Static load capacity for bench top 100 kg, total load capacity for frame 300 kg.



The new, innovative, patent pending height adjustment solution minimises the height exchange time between handled items and makes daily work more fluent, efficient, and ergonomic. Bench top is adjusted without load due to the constant force springs as an adjustment mechanism.

Grounding set for Treston Quick Edge workstation

Name	Code ESD
Grounding set for Treston Quick Edge workstation	TQE-ESD

With this grounding set you can use Treston Quick Edge workstation in EPAs.



Grounding set for Treston Quick Edge workstation

Spring set for Treston Quick Edge Workstation

Name	Code
Spring set for Treston Quick Edge Workstation	TQES

Replace the constant force spring set at least after every 10 000 operating cycles.



Quick Edge workstation can be equipped with castors.

Castor set ESD Ø 100 Code LCS100 ESD

TP - ideal basic workbench

- Stepless height adjustment with allen key between 650-900 mm.
- Upright tubes (ordered separately) allow to attach a wide range of accessories.

TP workbench

Bench size W x D mm	Max load kg	Code ESD
700 x 500	150	TP507 ESD
1000 x 500	150	TP510 ESD
1500 x 500	150	TP515 ESD
1000 x 700	300	TP710 ESD
1200 x 700	300	TP712 ESD
1500 x 700	300	TP715 ESD
1800 x 700	300	TP718 ESD
1500 x 900	300	TP915 ESD
1800 x 900	300	TP918 ESD

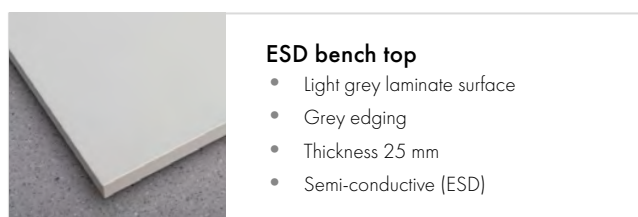

ESD bench top

- Light grey laminate surface
- Grey edging
- Thickness 25 mm
- Semi-conductive (ESD)

Lower steel shelf LSS

Name	Size W x D mm	Max load kg	Code ESD
Lower shelf	1418 x 460	30	LSS150
Lower shelf	1718 x 460	30	LSS180
Low M-divider hoops (4 pcs/set)	460 x 315		LDH

Hangs on the horizontal bars. Can be equipped with steplessly adjustable low M-divider hoops.



The TP bench can be equipped with castors!

Castor set Ø100, code ESD 863 429 -00. Insert set (required to fit castors), code 853 289-00
Load capacity with castors 150 kg. We recommend using the fixing frame for the castors. Always adjust the bench with castors to the lowest position when the bench is moved.

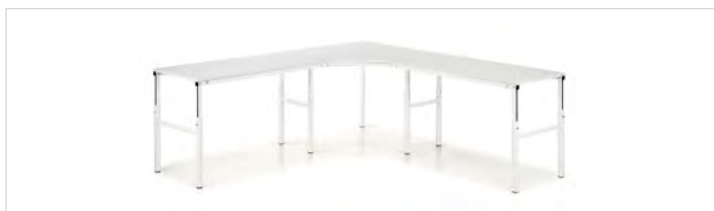

TP extension benches also available!

For more information please check our web site www.treston.com or Main catalogue 2023 page 41.

TP workbench examples

TP workbench 1

Qty	Name	Size mm	Code ESD
1	Workbench TP	1500 x 700	TP715 ESD
1	Accessory frame	1500	TPK15-49
1	Upright tube module	2 x M750	UTM2X750M-49



TP workbench 2

Qty	Name	Size mm	Code ESD
1	Workbench TP	1500 x 700	TP715 ESD
1	Accessory frame	1500	TPK15-49
1	Upright tube module	2 x M750	UTM2X750M-49
1	Light/balancer rail	2 x M750	918 49 006P
1	Treston NaturLite LED1200	1180	TNL1200
2	Steel shelf	M750 x 300	836 028-49
2	Bin profile	M750	859 151-49
10	Stacking bin		1525-4ESD



TP workbench 3

Qty	Name	Size mm	Code ESD
1	TP workbench	1200 x 700	TP712 ESD
1	Accessory frame	1200	TPK12-49
1	Upright tube module	1 x M1200	UTM1X1200M-49
1	Tilttable top shelf	M1200 x 300	TTSM12003-49
1	Light and balancer rail	M1200	918 49 010P
1	Treston IntoLite Led	850	TIL850



Watch this animation showcasing the versatile usage options

<https://vimeo.com/219469789>



TPH - standard workbench with one shelf

- Stepless height adjustment with allen-key between 650-900 mm.
- Includes a pair of uprights and one shelf

Workbench TPH

Bench size W x D mm	Shelf size W x D mm	Max load kg	Code ESD
1200 x 700	1200 x 310	300	TPH712 ESD
1500 x 700	1500 x 310	300	TPH715 ESD
1800 x 700	1800 x 310	300	TPH718 ESD
1500 x 900	1500 x 310	300	TPH915 ESD
1800 x 900	1800 x 310	300	TPH918 ESD



ESD bench top

- Light grey laminate surface
- Grey edging
- Thickness 25 mm
- Semi-conductive (ESD)

Lower steel shelf LSS

Name	Size W x D mm	Max load kg	Code
Lower shelf	1418 x 460	30	LSS150
Lower shelf	1718 x 460	30	LSS180
Low M-divider hoops (4 pcs/set)	460 x 315		LDH

Hangs on the horizontal bars. Can be equipped with steplessly adjustable low M-divider hoops.



Corner workbench TPH KK

Bench size W x D mm	Max load kg	Code ESD
1100 x 1100	150	TPH707 KK ESD
1300 x 1300	150	TPH909 KK ESD

A corner workbench can be used with two TPH benches (with one H-frame pair) to create a 90 °angle setup. TPH KK unit consists of a worktop, two H-frames and a leg in the middle. Front side 565 mm.



* Workbench with one H-frame pair.

TPH workbench examples

TPH workbench 1

Qty	Name	Size mm	Code ESD
1	TPH workbench	1500 x 700	TPH715 ESD
1	Auxiliary shelf	1500 x 310	SH150 ESD
1	Light steel cabinet, 2 x100	370 x 460 x 245	LMC02 ESD



TPH workbench 2

Qty	Name	Size mm	Code ESD
1	TPH workbench	1500 x 700	TPH715 ESD
1	Tool and lighting support	1500 x 600	KT150
1	Treston NaturLite LED	1200	TNL1200



TPH workbench 3

Qty	Name	Size mm	Code ESD
1	TPH workbench	1500 x 700	TPH715 ESD
1	Tool and lighting support	1500 x 600	KT150
1	Treston NaturLite LED	1200	TNL1200
1	Divider hoops set ESD, 5 pcs	400	PDH
1	Perforated panel	1415 x 750	RL150
1	Perforated panel connectors for TPH		RK1
1	Swivel arm with tray	460 x 210	CKV400 ESD
1	Component rack	455 x 200	EPL12 ESD
12	Stacking bin, black ESD	105 x 165 x 75	1015-4ESD
1	Drawer unit 45, 1x100	450 x 520 x 140	603 49 001



ESD accessories for Concept, TED, Quick Edge and TP

Non ESD certified accessories on page 47

Our Concept, TED, Quick Edge, and TP benches can be fitted with the same accessories and they are interchangeable.

Upright tubes are the basic element for accessorising our industrial furnishings. Accessories are attached to Concept, TED and TP benches with the aid of upright tubes or a complete, upright tube module.

The complete upright tube module includes upright tubes, horizontal profile, and fixing plugs. For the Concept bench, the upright tubes are attached to the rear case of the bench with the fixing plates that delivered with the bench. With the TP bench, you also need an accessory frame TPK (page 28), which also includes the fixing plates for the upright tubes. For the TED bench, upright tube pair with a flange is fitted on worktop with screws.

Upright tubes for Concept and TP

Name	Size W x D mm	Length mm	Code ESD
Upright tube	30 x 60	500	860 991-49
Upright tube	30 x 60	800	860 142-49
Upright tube	30 x 60	996	860 367-49
Upright tube	30 x 60	1359	860 024-49
Upright tube	30 x 60	1582	860 025-49
Horizontal profile	M500		HPM500-49
Horizontal profile	M750		HPM750-49
Horizontal profile	M900		HPM900-49
Horizontal profile	M1000		HPM1000-49
Horizontal profile	M1200		HPM1200-49
Horizontal profile	M1350		HPM1350-49
Horizontal profile	M1500		HPM1500-49
Horizontal profile	M1800		HPM1800-49
Horizontal profile	M2000		HPM2000-49
Fixing plug set (2 pcs)			FPSET

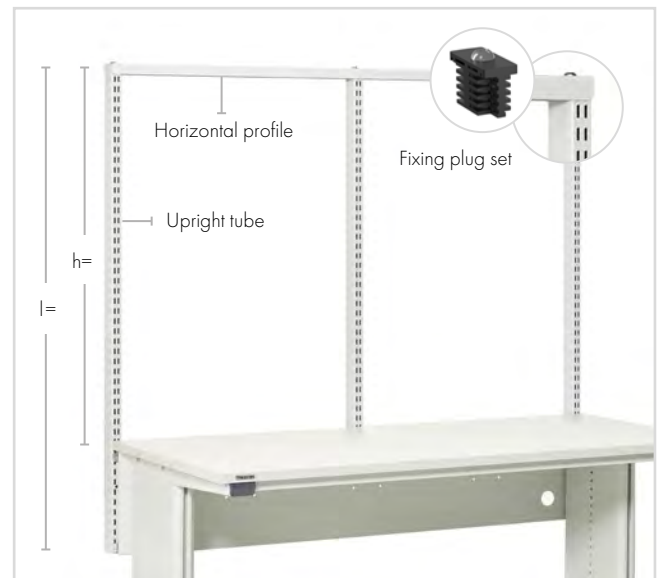

Upright tube modules and compatibility

	Suitable for bench widths C = Concept, TP = TP bench					Code ESD S	Code ESD M	Code ESD L
	1000	1200	1500	1800	2000	l = 996 mm h = 683 mm*	l = 1359 mm h = 1046 mm*	l = 1582 mm h = 1269 mm*
1 x M750	C	C/TP	C	C	C	UTM1X750S-49	UTM1X750M-49	UTM1X750L-49
1 x M900	C/TP	C/TP	C	C	C	UTM1X900S-49	UTM1X900M-49	UTM1X900L-49
1 x M1200		C/TP				-	UTM1X1200M-49	-
1 x M1500			C/TP	C	C	-	UTM1X1500M-49	-
1 x M1800				C/TP	C	-	UTM1X1800M-49	-
2 x M500	C	C				UTM2X500S-49	UTM2X500M-49	UTM2X500L-49
2 x M750			C/TP	C	C	UTM2X750S-49	UTM2X750M-49	UTM2X750L-49
2 x M900				C/TP	C	UTM2X900S-49	UTM2X900M-49	UTM2X900L-49
3 x M500			C	C		UTM3X500S-49	UTM3X500M-49	UTM3X500L-49
4 x M500					C	UTM4X500S-49	UTM4X500M-49	UTM4X500L-49

*h = module's height measured from Concept bench's top surface.

Load capacity 100 kg / module spacing.

Upright tube modules include 5 pcs of cable clips for easy cable management.

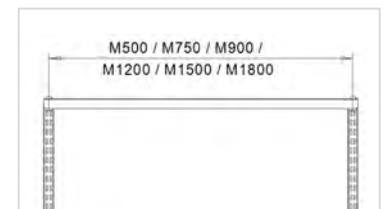

The modular (M) size refers to the distance between two upright tubes from the middle of the tube. The modular size is used to find the appropriate accessories.

Accessory frame for TP bench

Bench frame width mm	Fixing points for uprights	Code ESD
1000	1 x M900, 1 x M1000	TPK10-49
1200	1 x M750, 1 x M900, 1 x M1200	TPK12-49
1500	1 x M1500, 2 x M750	TPK15-49
1800	1 x M1800, 2 x M900	TPK18-49

Upright tubes or the upright tube module are always attached to TP bench with accessory frame. The accessory frame cannot be used on line or corner extensions.



Accessory frame for TP bench

Upright Tube Pair with a flange for TED bench

Size W x D x H mm	Code ESD
70 x 100 x 418	TTP400-49
70 x 100 x 793	TTP790-49
70 x 100 x 997	TTP990-49

Treston upright tubes enable TED electric desk to be accessorised in many ways. Fitted on worktop with screws.

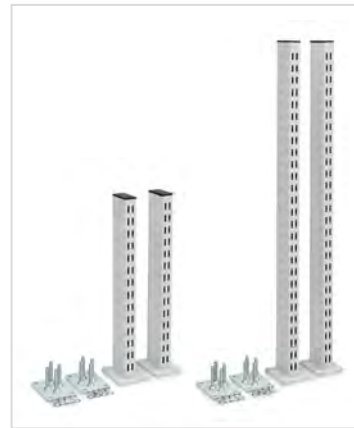

Upright tube pair with a flange



Aluminium bracket

Aluminium bracket

Name	Code ESD
Aluminium bracket	846 554-00

A separate aluminium bracket can be used to attach a single tube to any bench.



Light and balancer rail

Apart from the Treston Wave LED ESD and Naturlite LED Wing 500 all luminaires are fitted to light/balancer rails which are height and depth adjustable. Tool balancer rails and sliding pieces facilitate the use of heavy equipment. A tool balancer is fixed to the light/balancer rail.

Light and balancer rail (includes one sliding piece)

Modular size	Width of the front profile mm	Max load kg	Code ESD
2 x M500	1000	15	918 49 001P
2 x M500/1500	1500	15	918 49 002P
4 x M500	2000	15	918 49 003P
M750	750	15	918 49 004P
M750/900	900	15	918 49 013P
M750/1500	1500	15	918 49 005P
2 x M750	1500	15	918 49 006P
3 x M750	2250	15	918 49 012P
M900	900	15	918 49 007P
2 x M900	1800	15	918 49 008P
M900/1500	1500	15	918 49 009P
M1200	1200	15	918 49 010P
M1350	1350	15	918 49 011P

With extension benches you also need a center bracket, code 860 074-49



+

Lighting solutions from page 51.

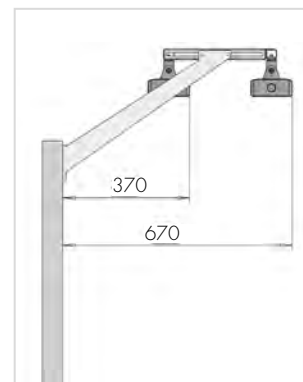
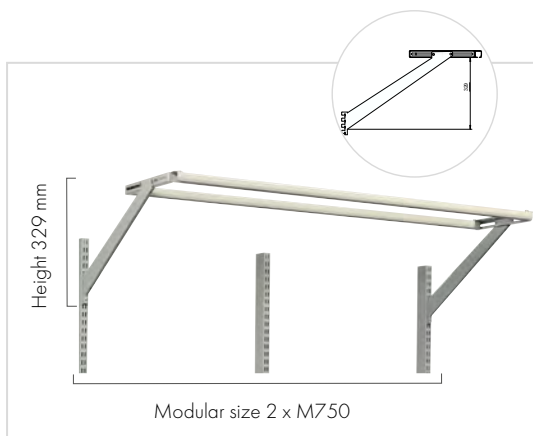
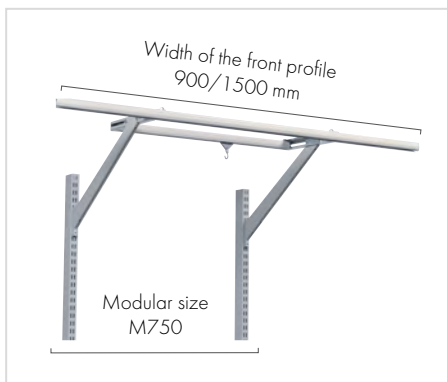

Tool balancers and other supplies

Name	Tool weight kg	Code ESD
Tool balancer 2DU	0,5 - 1	939 502-00
Tool balancer 4DU	1 - 2	939 503-00
Sliding piece with a snap hook		890 557-51



Tool balancer

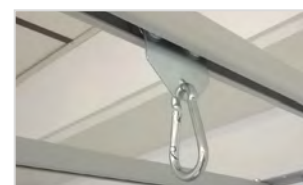

Sliding piece with a snap hook

Shelves

Tiltable top shelf TTS

Module	Size W x D mm	Max load kg	Code
M500	467 x 300	80	TSM5003-49
M500	467 x 400	80	TSM5004-49
M750	717 x 300	80	TSM7503-49
M750	717 x 400	80	TSM7504-49
M900	870 x 300	80	TSM9003-49
M900	870 x 400	80	TSM9004-49
M1000	967 x 300	80	TSM10003-49
M1000	967 x 400	80	TSM10004-49
M1200	1167 x 300	80	TSM12003-49
M1200	1167 x 400	80	TSM12004-49
M1350	1320 x 300	80	TSM13503-49
M1350	1320 x 400	80	TSM13504-49
M1500	1467 x 300	80	TSM15003-49
M1500	1467 x 400	80	TSM15004-49
M1800	1773 x 300	80	TSM18003-49
M1800	1773 x 400	80	TSM18004-49
M2000	1973 x 300	80	TSM20003-49
M2000	1973 x 400	80	TSM20004-49

Max. tilt 20 degrees (depth 300 mm) or 12,5 degrees (depth 400 mm). Front lip height 30 mm. Can also be installed at the back of the shelf.



Tiltable top shelf M500, M750, M900, M1000, M1200, M1350, M1500, M1800, M2000



Cable cover, TTS-shelf

Cable cover, for TTS-shelf

Module	Size D x H mm	Code
M750	612 x 125 x 19	CCM750-49
M900	815 x 125 x 19	CCM900-49
M1500	1362 x 125 x 19	CCM1500-49
M1800, M2000	1666 x 125 x 19	CCM1800-49



Accessory box for under TTS-shelf

Accessory box for under TTS-shelf

Suitable for	Size D x H mm	Code
Tiltable top shelf TTS depth 300 mm	220 x 300	ABTTS3-49
Tiltable top shelf TTS depth 400 mm	220 x 370	ABTTS4-49

Includes a a black ESD (-49) 3020 or 4020 bin.

Steel shelf

Module	Size W x D mm	Max load kg	Code
M500	490 x 300	50	860 804-49
M500	490 x 400	50	860 805-49
M750	740 x 300	50	836 028-49
M750	740 x 400	50	852 770-49
M900	890 x 300	50	852 283-49
M900	890 x 400	50	852 769-49
M1000	990 x 300	50	890 631-49
M1000	990 x 400	50	890 632-49
M1350	1340 x 300	50	860 787-49
M1350	1340 x 400	50	860 788-49
M1500	1490 x 300	50	890 756-49
M1500	1490 x 400	50	890 757-49



Steel shelf M500, M750, M900, M1000, M1350, M1500



Due to the dual-purpose shelf brackets, the steel shelf can be used either as tilted 20° or in a horizontal position. The shelf has an integrated edge, which can be used either in the front or back of the shelf, depending on the use of the shelf.

Divider hoops set (4 pcs)

Suitable for	Size D x H mm	Code
Tiltable top shelf TTS depth 300 mm	300 x 400	PDH300-49
Tiltable top shelf TTS depth 400 mm	400 x 400	PDH400-49

Divider pair

Suitable for	Size D x H mm	Code
Steel shelf depth 300 mm	285 x 190	010 004-49
Steel shelf depth 400 mm	385 x 190	010 005-49
Tiltable top shelf TTS depth 300 mm	285 x 190	861 116-49
Tiltable top shelf TTS depth 400 mm	385 x 190	861 118-49

Adjustable shelf

Module	Size W x D mm	Max load kg	Code
M500	470 x 505	100	920 49 001P
M500	470 x 650	100	920 49 002P
M750	720 x 505	100	920 49 005P
M750	720 x 650	100	920 49 006P
M900	870 x 505	100	920 49 009P
M900	870 x 650	100	920 49 010P
M1350	1320 x 505	100	920 49 013P
M1350	1320 x 650	100	920 49 014P

Adjustable shelf, stepless depth adjustment

Module	Size W x D mm	Max load kg	Code
M500	470 x 505	50	920 49 003P
M500	470 x 650	50	920 49 004P
M750	720 x 505	50	920 49 007P
M750	720 x 650	50	920 49 008P
M900	870 x 505	50	920 49 011P
M900	870 x 650	50	920 49 012P

+ Additional adjustable shelves on page 61.

Extendable shelf

Module	Size W x D mm	Max load kg	Code
M750	720 x 390	30	925 49 002P
M900	870 x 390	30	925 49 003P

Document shelf

Module	Size W x D mm	Max load kg	Code
M500	470 x 265	5	860 806-49
M750	720 x 265	5	860 115-49
M900	870 x 265	5	860 399-49

Flow-through shelf

Module	Size W x D mm	Max load kg	Code
M750	718 x 830	150	890 710-49

A flow-through shelf can fit two 400 mm deep bins in depth direction.



Divider hoops set



Divider pair

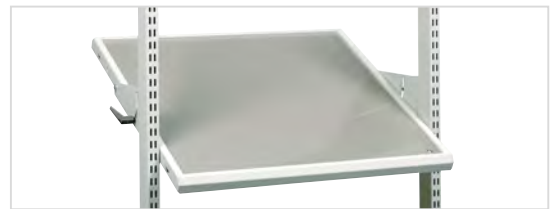

Adjustable shelf, tilting 0-25°



Steplessly adjustable shelf, tilting 0-25°



Extendable shelf, tilting 0-25°



Document shelf, tilting 10 - 75°



Flow-through shelf



Upright accessories

Adjustable auxiliary shelf

Name	Size W x D mm	Tilting	Max load kg	Code ESD
Adjustable auxiliary shelf	560 x 340	0-25°	15	927 49 001P
Adjustable auxiliary shelf	605 x 405	0-25°	15	927 49 002P



Adjustable auxiliary shelf

IT shelves and trays

Name	Size W x D x H mm	Max load kg	Code ESD
Laptop / printer shelf	365 x 365	25	930 49 001P
Keyboard tray for laptop shelf	480 x 270	5	860 904-49
Keyboard and mouse tray for laptop shelf	620 x 270	5	860 903-49
Keyboard tray (attached to the bench top)*	680 x 375 x 106 (outer) 620 x 305 x 90 (inner)	10	925 49 001P



Laptop/printer shelf with arm

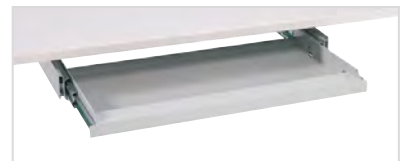

Keyboard tray (attached to the bench top)

*Suitable also for WB, TP and TPH benches.

Holder for Thin Client PC

Name	Size W x D x H mm	Max load kg	Code ESD
Holder for Thin Client PC	250 x 45-65 x 145	5	TCH

Fixed to keyboard tray 860941-49 or 860942-49.



Holder for Thin Client PC

LCD monitor holder for perforated panel

Name	Max load kg	Code ESD
LCD monitor holder for perforated panel	10	890 715-49

Suitable for VESA 75/100



LCD monitor holder for perforated panel

Display bracket for light duty for TED desk

Name	Suitable for	Max load kg	Code ESD
Display bracket for light duty for TED desk	TED	7	TDB-49

Suitable for VESA 75/100



Display bracket for light duty

LCD holder with double arm

Name	Size W x D x H mm	Max load kg	Code ESD
LCD holder with double arm*		15	930 49 002P
Keyboard tray for LCD holder	480 x 260	5	860 941-49
Keyboard and mouse tray for LCD holder	620 x 260	5	860 942-49

Fixed to keyboard tray 860941-49 or 860942-49.

*Suitable for VESA 75/100



LCD holder with double arm

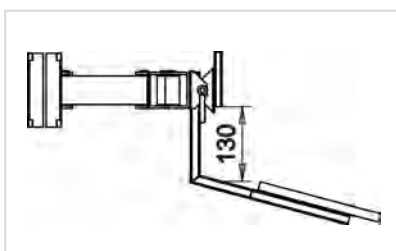

Maximum distance between the LCD holder and keyboard tray



LCD-holder & keyboard tray

Equipment tray

Name	Size W x D mm	Max load kg	Code ESD
Equipment tray	250 x 250 x 90	10	928 49 001P
Equipment tray	500 x 250 x 125	15	928 49 002P
Equipment tray *	500 x 250 x 125	30	928 49 003P

*Comes with heavy arm.



Equipment tray

Bin shelf

Name	Size W x D mm	Max load kg	Code ESD
Bin shelf	560 x 175 x 125	15	928 49 005P
Bin shelf	600 x 220 x 125	15	928 49 006P
Stand for picking bins**	560 x 165 x 355		860 113-49

**Space for 15 picking bins 30-1L-4ESD



Bin shelf



Stand for stacking bins

Document holders

Name	Size W x D mm	Max load kg	Code ESD
Document holder A4	290 x 330	5	928 49 008P
Document holder A3	418 x 330	5	928 49 009P



Document holder

Tool panel

Name	Size W x D mm	Max load kg	Code ESD
Tool panel	267 x 305	5	928 49 010P



Tool panel

Bin rails with arms

Name	Size W x D mm	Max load kg	Code ESD
Curved bin rail with arm	770 x 54	15	929 49 002P
Extension for curved bin rail with arm	770 x 54		860 911-49



Curved bin rail with arm



Extension for curved bin rail with arm

Rotating tool frame

Name	Size W x D mm	Max load kg	Code ESD
Rotating tool panel frame, height-adjustable arm	513 x 320	15	860 864-49P
Rotating tool panel frame, double arm	513 x 320	15	880 865-49P



Rotating tool panel frame

The rotating tool panel frame can be equipped with perforated panels and tool troughs. The rotating tool frame is compatible with all M500 accessories, such as the tool trough and the bin rails.

Plastic bins, hooks and tools in pictures are not included.



Rotating tool panel frame with double arm



Rotating tool panel frame with M500 perforated panel, M500 bin rails and 8 plastic ESD bins



Rotating tool panel frame with M500 perforated panel, aluminium bin rail M500 and auxiliary steel shelf

Accessories for rotating tool frame

Name	Size W x D mm	Max load kg	Code ESD
Perforated panel	470 x 300		860 951-49
Tool trough M500	470 x 150		860 952-49
Bin rail M500	492 x 90	15*	859 150-49
Light bin rail M500	492 x 54	10	860 953-49
Aluminium bin rail M500 for rotating tool panel	486 x 55 x 75	15	BP500C
Auxiliary steel shelf	217 x 298 x 20	3	ASSA4
Auxiliary steel shelf	159 x 254 x 50	2	ASSA5

*Actual bin rail max load 40 kg but with arm 15 kg.

Replacement arms (spare parts)

Name	Length mm	Max load kg	Code ESD
Double arm, 40 mm	200+200	10	880 020-49
Double arm, 60 mm	200+200	15	880 010-49
Heavy arm, 60 mm	287+221	30	860 993-49
Height-adjustable arm with gas spring, 60 mm (height adjustment range 165 mm)	375	15	860 985-49
Height-adjustable profile	55 x 80 x 590	15	860 997-49

LCD screen holder for 60 mm double, heavy or height adjustable arms: 860940-49.



Double arm



Heavy arm



Height-adjustable arm

Height-adjustable profile

When a position changes, the height must be adjusted

Frequent changes in the working position, such as changing from a sitting position to a standing position, require height-adjustable arm (860 985-49). The height-adjustable profile (860 997-49) can be attached to any rack with arm (such as the PC rack) that is pulled down and lifted back up according to the working position. The adjustment range is 450 mm.



Arm adapters for Concept/TP/TED accessories with arms (for example 93049002P)

Profile type	Workbench / trolley model	40 mm arm	60 mm arm
C-profiles	TPH, TPB	-	E824 081-49
AL2X aluminum profiles	WB	890 524-49	890 525-49
Aluminum profiles	WTR	E821 573-49	E821 572-49

Auxiliary top, fixed brackets

Name	Size W x D mm	Max load kg	Code ESD
Auxiliary top left	400 x 500	40	926 49 001P
Auxiliary top right	400 x 500	40	926 49 002P



Auxiliary top

Bottle holder

Name	Code ESD
Bottle holder (Ø 100) for upright tube	859 063-49



Bottle holder

Roll holder for upright tube

Name	Code ESD
Roll holder for upright tube (roll ø height 150 mm, width 320 mm)	860 841-49



Roll holder

Cable management

Cable ducts

Name	Size W x H mm	Suitable for module	Code ESD
Cable duct	467 x 360	M500	860 808-49
Cable duct	717 x 360	M750	860 044-49
Cable duct	870 x 360	M900	860 045-49

Suitable only for Concept bench. Fitted to upright tube.

Cable ducts hide the untidy cables from other equipment. This makes it easy to keep the back of the workstation and its surroundings tidy.

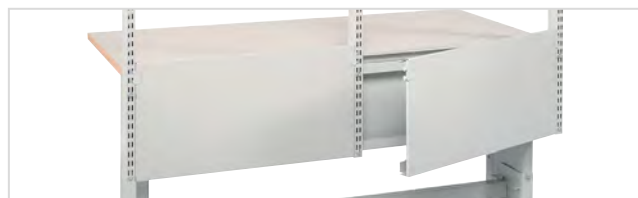

Hide wires and cables with a cable duct.

Horizontal cable troughs

Name	Size W x D x H mm	Suitable for module	Code ESD
Horizontal cable trough	737 x 97 x 45	M750	854 553-49
Horizontal cable trough	890 x 97 x 45	M900	854 554-49
Horizontal cable trough	1187 x 97 x 45	M1200	854 555-49
Horizontal cable trough	1337 x 97 x 45	M1350	890 551-49
Horizontal cable trough	1487 x 97 x 45	M1500	854 556-49
Horizontal cable trough	1793 x 97 x 45	M1800	854 557-49

Horizontal troughs effectively conceal the cables, without preventing maintenance access.

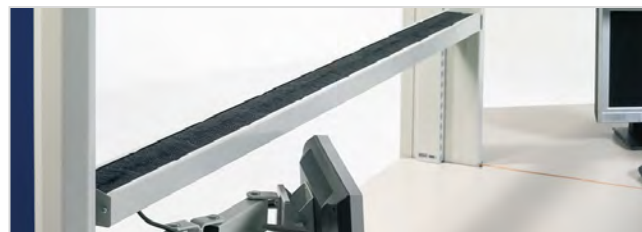

Fitted to upright tubes, the horizontal cable trough enables cables to be hidden at the top of the workstation.

Vertical cable trough

Name	Size W x D x H mm	Code ESD
Vertical cable trough	52 x 62 x 1360	861 130-49

The vertical cable trough is fitted on the side of the upright tube.

Vertical cable trough

**Treston Cable Tidy**

Name	Size W x D x H mm	Suitability	Code ESD
Treston Cable Tidy	800 x 62 x 100	TED	TCT-49

Treston cable tidy hides the cables below the worktop.

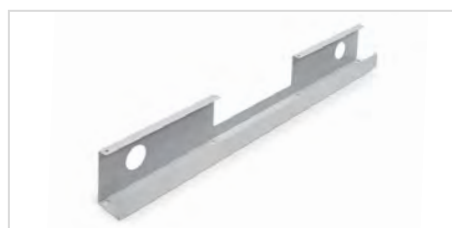

Treston Cable Tidy for TED



CPU cabinets and holders

1. CPU/printer holder, bar clamp

Size W x D x H mm	Max load kg	Suitable for	Code ESD
>150 x 500 x 85	20	Concept with accessory bar	860 551-49



2. CPU holder

Size W x D x H mm	Max load kg	Suitable for	Code ESD
180-225 x 450 x 50	20	Concept (allen key and hand crank)	860 552-49



3. CPU holder

Size W x D x H mm	Max load kg	Suitable for	Code ESD
180-225 x 450 x 50	20	Concept motor	860 740-49

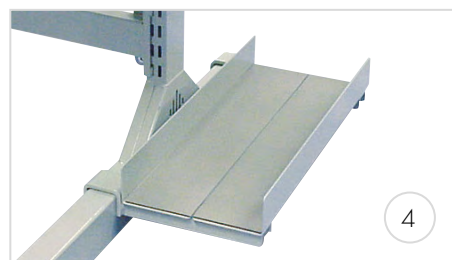

4. CPU holder

Size W x D x H mm	Max load kg	Suitable for	Code ESD
180-225 x 450 x 50	20	TP upright frame	860 553-49



5. CPU holder

Size W x D x H mm	Max load kg	Suitable for	Code ESD
180-225 x 450 x 50	20	TP/TPH benches	854 440-49

Footrests

Footrest, floor

Size W x D mm	Height	Tilting	Suitable for	Code ESD
550 x 350	100	5-30	All benches	860 947-49



Footrest, floor

Footrest, floor, height adjustable

Size W x D mm	Height	Tilting	Suitable for	Code ESD
550 x 350	90-280	5-30	All benches	860 137-49



Footrest, floor, height adjustable

Footrest, floor, with gas action

Size W x D mm	Height	Tilting	Suitable for	Code ESD
550 x 350	90-260	5-30	All benches	860 224-49



Footrest, floor, with gas action

Footrest, bar

Size W x D mm	Height	Tilting	Suitable for	Code ESD
550 x 350	90-280	5-30	Concept	860 136-49



Footrest, bar

Footrest, bar, with gas action

Size W x D mm	Height	Tilting	Suitable for	Code ESD
550 x 350	90-260	5-30	Concept	860 196-49



Footrest, bar, with gas action

Accessory bars

Name	Bench frame width mm	Depth adjustment mm	Code ESD
Accessory bar Concept	1000	-	860 084-49
Accessory bar Concept	1200	-	860 085-49
Accessory bar Concept	1500	150	860 088-49
Accessory bar Concept	1500	-	860 086-49
Accessory bar Concept	1800	150	860 089-49
Accessory bar Concept	1800	-	860 083-49
Accessory bar Concept	2000	150	860 090-49

The accessory bar can be used to fix a footrest or a CPU/printer holder. The accessory bar is included with the hand crank and motor adjustable Concept benches.

Stacking bins and shelf bins

Another way of ensuring an ergonomic working position and saving space is to use bin rails. The higher the rails are, the further they are from the workstation. To ensure an ergonomic working position, use the extension bracket pair on the higher rails. The bin rails are available in six standard module sizes.

Name	Suitable for module	Size W x D mm	Max load kg	Code ESD
Bin rail	M500	492 x 100	50	859 150-49
Light bin rail	M500	492 x 54	10	860 953-49
Bin rail	M750	742 x 100	50	859 151-49
Light bin rail	M750	742 x 54	10	860 955-49
Bin rail	M900	895 x 100	50	859 152-49
Light bin rail	M900	895 x 54	10	860 956-49
Bin rail	M1000	967 x 100	50	859 156-49
Bin rail	M1200	1167 x 100	50	859 157-49
Bin rail	M1350	1343 x 100	50	859 153-49
Bin rail	M1500	1493 x 100	50	859 154-49
Bin rail	M1800	1799 x 100	50	859 155-49
Extension bracket pair		60	50	860 919-49
Aluminium bin rail M500		486 x 55 x 75	40	BP500C
Aluminium bin rail M750		736 x 55 x 75	40	BP750C
Aluminium bin rail M900		889 x 55 x 75	40	BP900C
Aluminium bin rail M1350		1320 x 55 x 75	40	BP1350C
Aluminium bin rail M1500		1486 x 55 x 75	40	BP1500C
Aluminium bin rail M1800		1792 x 55 x 75	40	BP1800C
Auxiliary steel shelf		217 x 298 x 20	3	ASSA4
Auxiliary steel shelf		159 x 254 x 50	2	ASSA5

Light bin rail is recommended only for the small stacking bins.

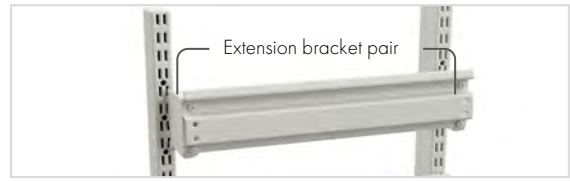

Bin rail with stacking bins.



Light bin rail with stacking bins.



Aluminium bin rail BP and ASSA4



Stacking bins

No.	Capacity l	Outer dims W x D x H mm	Inner dims W x D x H mm	Pack pcs	Code ESD*
1.	0,6	105 x 165 x 75	90 x 105 x 65	60	1015-4 ESD
2.	2,7	149 x 250 x 130	125 x 185 x 115	30	1525-4 ESD
3.	5,0	186 x 300 x 156	155 x 230 x 140	24	1930-4 ESD
4.	7,2	186 x 400 x 156	155 x 330 x 140	24	1940-4 ESD
5.	1,1	99 x 160 x 70	85 x 100 x 62	60	30-1L-4 ESD
6.	2,2	198 x 160 x 70	175 x 100 x 62	30	30-2L-4 ESD
7.	2,2	198 x 160 x 70	175 x 100 x 62 (2 fixed length dividers)	30	30-23L-4 ESD

Labels and cross dividers

Labels + shields	Pack min. order	Cross divider	Pack pcs
E10	60		
E15	30	V-14	30
E20	24	V-19	24
E20	24	V-19	24

*) Order number/one item.

Fixing stacking bins on the bin rail

Bin rail	M500	M750	M900	M1350	M1500	M1800	Curved bin rail
1015	4	7	8	12	14	17	
1525	3	5	6	9	10	12	
1930 & 1940	2	4	4	7	8	9	
30-1L	5	7	9	13	15	17	5
30-2L & 30-23L	2	3	4	7	7	9	



Shelf bins

No.	Capacity l	Outer dims W x D x H mm	Inner dims W x D x H mm	Pack pcs	Code ESD*	Cross dividers	
1.	1,9	92 x 400 x 82	75 x 357 x 70	30	4010-4 ESD	D-10-4ESD	6
2.	2,4	92 x 500 x 82	75 x 457 x 70	30	5010-4 ESD	D-10-4ESD	8
3.	4,2	186 x 400 x 82	167 x 357 x 70	15	4020-4 ESD	D-20-4ESD	6
4.	5,3	186 x 500 x 82	167 x 457 x 70	15	5020-4 ESD	D-20-4ESD	8
5.	6,5	186 x 600 x 82	167 x 557 x 70	15	6020-4 ESD	D-20-4ESD	10

*) Order number/one item.

Please see our wide bin selection in our Main catalogue.

treston.com/catalogues-and-brochures

Perforated panels

Perforated panels for upright tubes

Name	Module	Size W x H mm	Code ESD
Perforated back panel	M500	468 x 389	861 501-49
Perforated back panel	M750	718 x 389	861 511-49
Perforated back panel	M750	718 x 612	861 512-49
Perforated back panel, insulated	M750	718 x 612	861 701-49
Perforated back panel	M750	718 x 1003	861 514-49
Perforated back panel	M900	871 x 389	861 516-49
Perforated back panel	M900	871 x 612	861 517-49
Perforated back panel	M900	871 x 1003	861 519-49
Perforated back panel	M1000	968 x 389	861 532-49
Perforated back panel	M1000	968 x 612	861 538-49
Perforated back panel	M1200	1168 x 389	861 533-49
Perforated back panel	M1350	1318 x 389	861 521-49
Perforated back panel	M1500	1474 x 389	861 526-49
Perforated back panel	M1800	1774 x 389	861 531-49

Fastened to the upright tubes (see page 27).

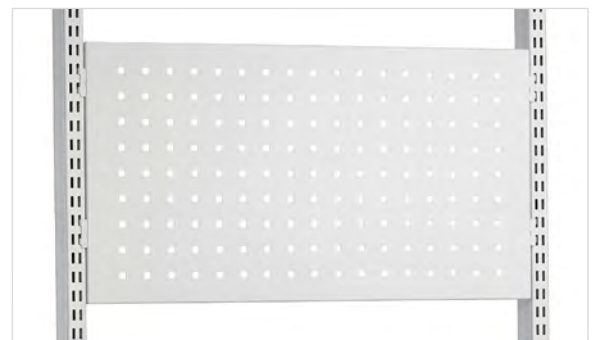

Auxiliary steel shelf for perforated panel

Size W x D x H mm	Suitable for	Code ESD
159 x 243 x 56	Perforated panel	ASSA5PP

Auxiliary steel shelf for A5 documents, tape dispenser or handheld scanner. Attached to the perforated panel.

Auxiliary steel shelf for perforated panel



ESD accessories for WB

Non ESD certified accessories on page 47

Upright profiles AL2X

Size W x H mm	Suitable for	Code ESD
1063 x 900	WB811	AL2X110 W
1489 x 900	WB815	AL2X150 W
1789 x 900	WB818	AL2X180 W

Needed for mounting accessories to WB benches. Includes 2 vertical and 1 horizontal profile. With 3 cable clips (CC8). Load capacity 100 kg/AL2X.



Upright profiles AL2X

Accessory frame AKK

Size W x D mm	Suitable for	Code ESD
730 x 540	AL2X150 W AL2X180 W	AKK70
690 x 500 + 690 x 500	AL2X150 W	AKK150
690 x 500 + 990 x 500	AL2X180 W	AKK180

The accessory frame divides the space between the upright profiles into 2 modules. AKK frame includes 1 vertical and 1 horizontal profile. Useable height 500 mm.



Accessory frame AKK

Support bracket HSB

Length mm	Suitable for	Code ESD
1073	AL2X110 W	HSB110
1500	AL2X150 W	HSB150
1800	AL2X180 W	HSB180

Support bracket of steel for suspending power tools and lighting units. Mount on upright profiles.



Support bracket HSB

Cable tidy WBCT

Size W x D x H mm	Suitable for	Code ESD
948 x 64 x 204	WB811	WBCT110
1375 x 64 x 204	WB815	WBCT150
1675 x 64 x 204	WB818	WBCT180

Mount on leg frame. We recommend using the cable tidy WBCT with WB Allen-key adjustable benches. The cable tidy is standard equipment on WB C and WB EL models.



Cable tidy WBCT

Shelf ALH

Size W x D mm	Suitable for	Code ESD
1073 x 310	AL2X110 W, combination AL2X180 W + AKK180	ALH110 ESD
1500 x 310	AL2X150 W	ALH150 ESD
1800 x 310	AL2X180 W	ALH180 ESD

Height adjustable shelf. 25 mm laminated particle board. Load capacity 50 kg. Mount on upright profiles.



Shelf ALH

Divider hoops PDH

Height mm	Suitable for	Code ESD
400	ALH	PDH

Used in combination with shelf ALH. Comes in sets of 5.

**Divider hoops PDH****Backstop LIST**

Size W x D x H mm	Suitable for	Code ESD
1400 x 52 x 27	ALH 150 ESD, AT150 ESD	LIST150
1700 x 52 x 27	ALH180 WB ESD, AT180 WB ESD	LIST180

Prevents items from falling off the shelf. Can be fixed on the lower shelf AT or on the shelf ALH.

**Backstop LIST****Adjustable shelf ASH**

Size W x D mm	Suitable for	Code ESD
660 x 400	AKK70, AKK150, AKK180	ASH70 ESD
960 x 400	AKK180, AL2X110W	ASH100 ESD

Continuous adjustment for depth, height and angle. Shelf of 25 mm laminated particle board. Lipped front edge. Load capacity 35 kg static load. Mount on accessory frame AKK.

**Adjustable shelf ASH****Lower shelf AT**

Size W x D mm	Max load kg	Suitable for	Code ESD
828 x 400	50	WB811	AT110 WB ESD
1255 x 400	50	WB815	AT150 WB ESD
1555 x 400	50	WB818	AT180 WB ESD

Height adjustable lower shelf, 25 mm laminated particle board. Mount between the legs.

**Lower shelf AT****Perforated panel ARL**

Size W x H mm	Suitable for	Code ESD
668 x 500	AKK70, AKK150	ARL70
968 x 500	AKK180, AL2X110W	ARL100

Mount on accessory frame AKK. The size of the perforation is 9 x 9 mm, center to center 38 mm.

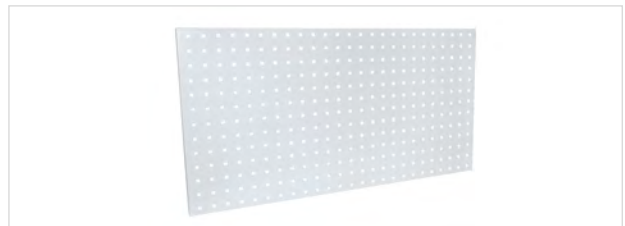
**Perforated panel ARL****Auxiliary steel shelf for perforated panel**

Size W x D x H mm	Suitable for	Code ESD
159 x 243 x 56	Perforated panel ARL	ASSA5PP

Auxiliary steel shelf for A5 documents, tape dispenser or handheld scanner. Attached to the perforated panel.

**Auxiliary steel shelf for perforated panel****Bin profile BP**

Length mm	Suitable for	Code ESD
685	AKK 70, AKK150, AKK180	BP70 ESD
985	AKK180, AL2X110W	BP100 ESD

Aluminium profile for stacking and picking bins. Mount on accessory frame AKK.

**Bin profile BP**

Auxiliary steel shelf ASSA

Size W x D x H mm	Suitable for	Code ESD
217 x 298 x 20	BP	ASSA4
159 x 254 x 50	BP	ASSA5

Shelf for A4/A5 paper and tape dispensers (max 2 pcs per shelf). Mounted on bin profile. Max load 3 kg.



Auxiliary steel shelf ASSA4

Keyboard shelf WKA

Size W x D mm	Suitable for	Code ESD
500 x 220 (shelf)	AL2X upright profiles	WKA ESD

Keyboard shelf with swivel arm. Epoxy powder coated steel. Load capacity 15 kg. Arm length 220 mm.



Keyboard shelf WKA

Swivel arm with tray AKV

Size W x D mm	Suitable for	Code ESD
460 x 210 (tray)	AL2X upright profiles	AKV400 ESD

Lockable, angle adjustable steel tray with swivel radius of 360°. Length of swivel arm 590 mm. Max. load 15 kg.



Swivel arm with tray AKV

Component rack EPL

Size W x D x H mm	Suitable for	Shelves number	Code ESD
455 x 200 x 290	AKV	3	EPL12 ESD

Rack with three fixed shelves. Semiconductive epoxy powder coated steel in light grey (RAL 7035). Bins ordered separately, page 50. Component rack holds: 12 stacking bins 1015-4ESD or 12 picking bins 30-1L-4ESD or 6 picking bins 30-2L-4ESD or 6 picking bins 30-23L-4ESD.



Component rack EPL

Document stand WDA

Size W x H mm	Suitable for	Code ESD
440 x 300	AL2X upright profiles	WDA ESD

Document stand A3 with swivel arm. Epoxy powder coated steel: light grey. Arm length 220 mm. Tilt 75°.



Document stand WDA

Tool tray PTH

Size W x D mm	Suitable for	Code ESD
1000 x 60	WB and TED benches, Concept motor benches.	PTH100

The tool tray guarantees a clean working space, while tools are close to hand.



Tool tray PTH

ESD accessories for TPH

Non ESD certified accessories on page 47

Tool and lighting support KT

	Size W x D mm	Suitable for	Code ESD
	1200 x 600	TPH712	KT120
	1500 x 600	TPH715/915	KT150
	1800 x 600	TPH718/ 918	KT180
Extra C-profile	1500	KT150	SPR150
Extra C-profile	1800	KT180	SPR180

For suspending power tools and lighting units. Includes one C-profile bar with sliding hook.



Tool and lighting support KT

Upright profiles HKCP

Height mm	Suitable for	Code ESD
1470	TPH	HKCP147

If you mount both perforated panel RL and cable channel TJK to TPH benches, you must order extra-high upright profiles.



Upright profiles HKCP

Auxiliary shelf SH

Size W x D mm	Max load kg	Suitable for	Code ESD
1200 x 310	50	TPH712	SH120 ESD
1500 x 310	50	TPH715/ 915	SH150 ESD
1800 x 310	50	TPH718/ 918	SH180 ESD

Height adjustable shelf. 25 mm laminated particle board .



Auxiliary shelf SH

Backstop LIST

Size W x D x H mm	Suitable for	Code ESD
1400 x 52 x 27	SH150 ESD	LIST150
1700 x 52 x 27	SH180 ESD	LIST180

Prevents items from falling off the shelf. Can be fixed on the shelf SH.



Backstop LIST

Divider hoops PDH

Height mm	Suitable for	Code ESD
400	TPH	PDH

Used in combination with shelf SH. Comes in sets of 5.



Divider hoops PDH



Lower steel shelf LSS

Size W x D mm	Max load kg	Suitable for	Code ESD
1418 x 460	30	TPH715/ 915	LSS150
1718 x 460	30	TPH718/ 918	LSS180

Hangs on the horizontal bars. Can be equipped with steplessly adjustable low M-divider hoops (4 pcs/set, code LDH).

Lower steel shelf LSS
Metal shelf TH

Size W x D mm	Max load kg	Suitable for	Code ESD
1119 x 145	30	TPH712	TH120 ESD
1419 x 145	30	TPH715/ 915	TH150 ESD
1719 x 145	30	TPH718/ 918	TH180 ESD

Adjustment for depth, height and angle. For stacking and picking bins. Load capacity 30 kg.

Metal shelf TH
Bin profile BP

Width mm	Max load kg	Suitable for	Code ESD
profile 1115	15	TPH712	BP120 ESD
profile 1415	15	TPH715/ 915	BP150 ESD
profile 1715	15	TPH718/ 918	BP180 ESD

Aluminium profile for stacking and picking bins.

Bin profile BP
Auxiliary steel shelf ASSA

Size W x D x H mm	Suitable for	Code ESD
217 x 298 x 20	BP	ASSA4
159 x 254 x 50	BP	ASSA5

Shelf for A4/A5 paper and tape dispensers (max 2 pcs per shelf). Mounted on bin profile. Max load 3 kg.

Auxiliary steel shelf ASSA
Perforated panel RL

Size W x H mm	Suitable for	Code ESD
1115 x 750	TPH712	RL120
1415 x 750	TPH715/ 915	RL150
1715 x 750	TPH718/ 918	RL180
Connector set for RL perforated panels	TPH	RK1

Robust, perforated steel panel. 9 mm perforations at 38 mm centres. Mount on TPH-benches with connectors RK 1. Can also be attached to a wall with screws (included).

Perforated panel RL

Auxiliary steel shelf for perforated panel

Size W x D x H mm	Suitable for	Code ESD
159 x 243 x 56	Perforated panel RL	ASSA5PP

Auxiliary steel shelf for A5 documents, tape dispenser or handheld scanner. Attached to the perforated panel.



Auxiliary steel shelf for perforated panel

Cable tidy TPHCT

Size W x D x H mm	Suitable for	Code ESD
1115 x 45 x 205	TPH712	TPHCT120
1415 x 45 x 205	TPH715/ 915	TPHCT150
1715 x 45 x 205	TPH718/ 918	TPHCT180

Mounted between C-profiles below worktop. Of perforated epoxy powder coated steel.



Cable tidy TPHCT

Swivel arm with tray CKV

Size W x D mm	Max load kg	Suitable for	Code ESD
Tray 210 x 460	15	TPH	CKV400 ESD

Swivel arm with lockable, angle adjustable steel tray. Load 15 kg. Mount on C-profile.



Swivel arm with tray CKV

Component rack EPL

Size W x D x H mm	Suitable for	Shelves number	Code ESD
455 x 200 x 290	CKV	3	EPL12 ESD

Rack with three fixed shelves. Of semiconductive epoxy powder coated steel in light grey (RAL 7035).



Component rack EPL, swivel arm with tray AKV and bins

CPU holder

Size W x D x H mm	Max load kg	Suitable for	Code ESD
180-225 x 450 x 50	20	TP/TPH	854 440-49



CPU holder

Other ESD accessories

Earthing supplies

Name	Press button	Resistance	Code ESD
Earthing box	3 x 10 mm	1 Mohm	J6603
Earth junction box, yellow. Cable 2 m.			860 522-00
Earthing cable, black, 1,5 m	10 mm / M5 terminal	1 Mohm	860 520-00
Earthing cable 5 m	10 mm		MK3040
Press stud	10 mm / female		PN3034



Earthing box



Earth junction box, yellow

Wrist straps

Name	Press button	Resistance	Code ESD
Adjustable wrist strap	7 mm	1 Mohm	R2216
Metal wrist strap	7 mm	1 Mohm	R2206

Wrist strap set includes wrist band and coiled cord. Earth lead with 1 megaohm resistor, length 3,6 m. Includes 7 mm press stud for connection to wrist strap and 10 mm press stud for connection to earthing point.



Earthing cable, black



Earthing cable

ESD mats

Name	Size W x D mm	Code ESD
ESD Ergo floor mat	950 x 650	852 880-00
ESD bench top mat*	1,22 x 10,00 m (12,20 m ²)	PM157

*Resistant to heat, solder flux, most chemicals and solvents. The ESD mats are to EN 61340-5-1 standards. Abraded non slip underside. Does not contain PVC. Supplied by the metre or in rolls. Colour: platinum grey. Resistance surface to ground: $7,5 \times 10^5 - 10^7$ ohm.

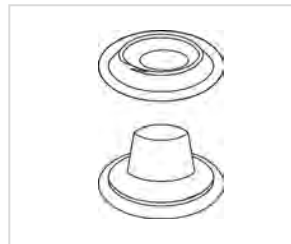

Press stud



Adjustable wrist strap



Metal wrist strap



ESD Ergo floor mat



ESD bench top mat

Non ESD certified accessories



All non ESD certified accessories are EPA –compatible when their combination of the potential charge level and physical distance to the ESDS –related parts is managed by ESD standard IEC 61340-5-1

Adapter set AS

Name	Suitable for	Code
Adapter set for Concept/TED/TP uprights, TPH C-profiles	MH / MA / MA2	AS2
Adapter for Concept/TED/TP uprights	MA4	AS4
Adapter for TPH C-profiles	MA4	AS4C

The above adapter set/adapters are needed for fixing MH/MA/MA2/MA4 to the uprights. Adapters are not required for WB benches with AL2X uprights.



Adapter set AS2



Adapter AS4



Adapter AS4C

LCD bracket MH

Name	Max load kg	Suitable for	Code
LCD bracket MH	15	Concept, TED, TP, TPH, WB	MH

The quick-release mechanism is equipped with the standard used flat-screen mount 75 x 75 and 100 x 100 for the mounting of all normal flat-screens. **Adapter set AS2 is needed for mounting LCD bracket MH to Concept, TED, TP and TPH benches, ordered separately.**



LCD bracket MH

LCD swivel arm MA

Name	Max load kg	Suitable for	Code
LCD swivel arm MA	10	Concept, TED, TP, TPH, WB	MA

The quick-release mechanism is equipped with the standard flat-screen mount 75 x 75 and 100 x 100 for the mounting of all normal flat-screens. The arm is double articulated, turns through a radius of 180° and will extend between 95-425 mm from the upright. **Adapter set AS2 is needed for mounting LCD swivel arm MA to Concept, TED, TP and TPH benches, ordered separately.**



LCD swivel arm MA

LCD swivel arm MA2

Name	Max load kg	Suitable for	Code
LCD swivel arm MA2	15	Concept, TED, TP, TPH, WB	MA2

The quick-release mechanism is equipped with the standard, widely used flat-screen mount 75 x 75 and 100 x 100 for the mounting of all normal flat-screens. The arm is double articulated, turns through a radius of 180° and will extend between 95-425 mm from the upright. **Adapter set AS2 is needed for mounting LCD swivel arm MA2 to Concept, TED, TP and TPH benches, ordered separately.**



LCD swivel arm MA2



LCD screen holder with height adjustable arm MA4

Name	Max load kg	Suitable for	Code
LCD screen holder MA4	2-7	Concept, TED, TP, TPH, WB	MA4

Highly ergonomic and easily height adjustable monitor arm with a gas spring. Easy mounting of the monitor with a quick-release mechanism, standard flat screen mount 75 x 75 mm and 100 x 100 mm for LCD screens. Cable management by cable clips. The double arm turns through a radius of 180 and will extend between 80-500 mm from the upright. **Adapter AS4/AS4C is needed for mounting LCD swivel arm MA4 to Concept, TED, TP and TPH benches, ordered separately.**



LCD screen holder MA4

Tablet bracket MY

Name	Suitable for	Code
Tablet bracket MY	MH, MA or MA2	MY

For 7-10" tablets. Requires either an MH, MA or MA2 swivel arm.



Tablet bracket MY

PC stand CPU

Width	Height	Suitable for	Code
130-240 mm	395-500 mm	WB, TP/TPH, Concept (depth 750/900 mm)	CPU
340-460 mm	180-285 mm	benches, TED, SAP, WTR and Concept trolleys	

An adjustable holder for either vertical or horizontal CPU, to mount underneath the table worktop.



PC stand CPU

CC cable clip set for Concept / TP

Name	Suitable for	Code
Cable clip set (5 pcs)	Concept/TP upright tubes	CC5

For easy cable management, suitable for up to five cables.



Cable clip set CC5

Cable clip set for WB

Set	Suitable for	Code
Cable clip set (5 pcs)	WB AL2X upright profiles	CC8

The cable clip set will hold cables etc. securely and neatly in place along the bench frame. The clips locate in the 8 mm profile slot.



Cable clip set CC8

Cable clip set for TPH

Set	Suitable for	Code
Cable clip set (5 pcs)	TPH	CC 12

The cable clip set will hold cables etc. securely and neatly in place along the bench frame. The clips locate in the 12 mm profile slot.



Cable clip set CC12

Treston power rails

New Treston power rails include USB-charging and also fault current protection is available in most of the standard rail lengths available from stock. Stock selection also includes three lengths with 2 x CAT6A data connectors. Also versions with other data and audio connectors and customised combinations of these are available on request.

Power rails come with brackets for fixing to Treston workstations. Rails can be fixed vertically on upright or aluminum profile, horizontally on aluminum profile or on M750 and M900 modules between uprights. With the new bracket set rails can also be fixed straight to the table top or perforated panel. A power rail can be mounted to four different angle on brackets. Length of rail can limit the mounting possibilities.



Ideal mounting for different lengths

Code	Length	Concept, TP Uprights	WB Aluminum profile	TPH	TED
TPR3-	331	Vertical	Hor/Ver	On table top	Upright vertical
TPR4-	468	Vertical	Hor/Ver	On table top	On table top
TPR7-	683	M750 horizontal	Hor/Ver	On table top	M750
TPR9-	836	M900 horizontal	Hor/Ver	On table top	M900
TPR14-	1400	On table top	On table top	On table top	On table top
TPR17-	1700	On table top	On table top	On table top	On table top

Power rails

Description	Length	Code
1 3 sockets + 2 x USB	331	TPR3-001
2 6 sockets + switch + 2 x USB	468	TPR4-001
3 6 sockets + switch + 2 x USB + 2 x CAT6A	468	TPR4-003
4 4 sockets + switch + fault current protection	468	TPR4-004
5 6 sockets + switch	468	TPR4-005
6 5 sockets + switch + 2 x USB	683	TPR7-001
7 5 sockets + switch + 2 x USB + 2 x CAT6A	683	TPR7-003
8 4 sockets + switch + fault current protection + 2 x USB	683	TPR7-008
9 10 sockets + switch	683	TPR7-038
10 6 sockets + switch + 2 x USB	836	TPR9-001
11 6 sockets + switch + 2 x USB + 2 x CAT6A	836	TPR9-003
12 6 sockets + switch + fault current protection + 2 x USB	836	TPR9-010
13 6 sockets + switch + 2 x USB	1400	TPR14-001
14 6 sockets + switch + fault current protection + 2 x USB	1400	TPR14-010
13 6 sockets + switch + 2 x USB	1700	TPR17-001
14 6 sockets + switch + fault current protection + 2 x USB	1700	TPR17-010



Lighting



All lighting units are EPA –compatible when their combination of the potential charge level and physical distance to the ESDS –related parts is managed by ESD standard IEC 61340-5-1

Treston NaturLite LED



Treston NaturLite LED Plus 1200
Light with tunable colour tone



Treston NaturLite LED 900
Dimmable light for smaller tables



Treston NaturLite LED 1200
Dimmable light for wider tables



Treston NaturLite LED Wing 500
Versatile task light with dimming

Name	Control	Colour temperature	Illuminance ±10% (@1 meter)	Luminous flux	Power	Size W x D x H mm	Suitability	Code
1. Treston NaturLite LED Plus 1200	Controlled via mobile app or separate remote control + ON/OFF button in the luminaire body	2700 - 6500 K	@4000 K: 2800 lx (1000 - 2800 lx depending on the colour temperature)	3200-6300 lm (depending on the selected colour temperature)	60 W	1180 x 120 x 50	All Treston and various other industrial workbenches	TNL1200P
Remote control for Treston NaturLite LED Plus 1200	Easy to use and save presets via mobile app. White.					90 x 90 x 12	Treston NaturLite LED Plus 1200	TNLPR
2. Treston NaturLite LED 1200	Touch dim button switch for ON/OFF and dimming in the luminaire body	4000 K	3100 lx	7100 lm	56 W	1180 x 120 x 50	All Treston and various other industrial workbenches	TNL1200
3. Treston NaturLite LED 900	Touch dim button switch for ON/OFF and dimming in the luminaire body	4000 K	2300 lx	5200 lm	42 W	900 x 120 x 50	All Treston and various other industrial workbenches	TNL900
4. Treston NaturLite LED Wing 500	Touch dim button switch for ON/OFF and dimming in the luminaire body	4000 K	800 lx	1750 lm	14 W	430 x 120 x 50 mm (+ bracket 95/120 mm)	Concept, WB, TED and TP benches, TPH and TPB benches*	TNL500W

Common features: Dimmable, Lifetime > 50 000 hours (L90B10), Color Rendering Index CRI > 80, High quality LED (MacAdams < 3) Aluminium body, 2 years guarantee, Enclosure protection IP20

* TPH and TPB benches require bracket 890 683-49



Watch this animation and get the main facts of the Treston NaturLite LED lights in less than 2 minutes: <https://vimeo.com/241502723>



Cutting edge technology

- Tunable colour tone (2700-6500 K)
- Power 14-60 W (max)
- Illuminance 800-3100 lx \pm 10 % (1 meter)
- Lifetime > 50 000 hours (L90B10)
- Color Rendering Index CRI > 80
- High quality LED (MacAdams < 3)
- Dimmable 1/10-100%
- Lean design
- 2 years guarantee
- Suitable for all Treston and various other industrial workbenches
- Enclosure protection IP20



- ✓ Adjustability helps to find optimal lighting conditions.
- ✓ Timeless design brings functional beauty to industrial environments and it is never out of style.
- ✓ Easy and fast to install – just click, slide and screw.
- ✓ High-quality LED lights with high-quality drivers are care-free for years to come. Low maintenance, just keep them clean!
- ✓ Designed and manufactured in Finland.



Treston NaturLite LED Wing 500

- Versatile task light
- Working area with or without shadows
- Also suitable in the middle of the table

Optimal light for industrial environments: Treston IntoLite LED



- ✓ Good quality, bright and long lasting light.
- ✓ Light with basic features and capability to give optimal light to workstation.

Name	Control	Colour temperature	Illuminance $\pm 10\%$ (@1 meter)	Luminous flux	Power	Size W x D x H mm	Suitability	Code
Treston IntoLite LED	Touch button switch for ON/OFF	4000K	1800 lux $\pm 10\%$	3800 lm	36W	850 x 67 x 80	All Treston and various other industrial workbenches	TIL850

Common features: Lifetime > 50 000 hours (L70B10), 2 years guarantee, Enclosure protection IP20

Compatibility with light and balancer rails

	Module / suitable for	Front profile width mm	Code	Compatible lighting units
Light and balancer rail (Concept, TED, Quick Edge and TP benches)	2 x M500	1000	91849001P	TNL900, TIL850
	2 x M500/1500	1500	91849002P	TNL900, TNL1 200, TNL1 200P, TIL850
	4 x M500	2000	91849003P	TNL900, TNL1 200, TNL1 200P, TIL850
	M750	750	91849004P	-
	M750/900	900	91849013P	TNL900, TIL850
	M750/1500	1500	91849005P	TNL900, TNL1 200, TNL1 200P, TIL850
	2 x M750	1500	91849006P	TNL900, TNL1 200, TNL1 200P, TIL850
	3 x M750	2250	91849012P	TNL900, TNL1 200, TNL1 200P, TIL850
	M900	900	91849007P	TNL900, TIL850
	2 x M900	1800	91849008P	TNL900, TNL1 200, TNL1 200P, TIL850
	M900/1500	1500	91849009P	TNL900, TNL1 200, TNL1 200P, TIL850
	M1200	1200	91849010P	TNL900, TNL1 200, TNL1 200P, TIL850
	M1350	1350	91849011P	TNL900, TNL1 200, TNL1 200P, TIL850
Support bracket HSB (WB benches)	AL2X110W	1073	HSB110	TNL900, TIL850
	AL2X150W	1500	HSB150	TNL900, TNL1 200, TNL1 200P, TIL850
	AL2X180W	1800	HSB180	TNL900, TNL1 200, TNL1 200P, TIL850
Tool and lighting support KT (TPH benches)	TPH712	1200	KT120	TNL900, TNL1 200, TNL1 200P, TIL850
	TPH715/915, TPB915	1500	KT150	TNL900, TNL1 200, TNL1 200P, TIL850
	TPH718/918, TPB918	1800	KT180	TNL900, TNL1 200, TNL1 200P, TIL850

Magnifying lamp

Treston Wave LED ESD



- ✓ Lamp can be easily adjusted to desired position thanks to very precise and flexible 3-joint arm.
- ✓ Lamp offers shadow-free magnification with light coming from both sides.
- ✓ Wave LED ESD is suitable for use in EPA-areas.
- ✓ Suitable for all Treston Workbenches and other manufacturers' workbenches

Name	Control	Colour temperature	Illuminance ±10% (@1 meter)	Luminous flux	Power	Size W x D x H mm	Fixing	Code
Treston Wave LED ESD	2-sided touch button with 4 level dimming	4000K	1500 lx	764 lm	13W	Lamp 227 x 225 x 40 mm, 3-joint arm length 500 + 550 mm	Table clamp (max thickness 72 mm)	TWL ESD

Common features: Lifetime > 50 000 hours, 5 years guarantee, Enclosure protection IP20. Power cord 1,7m with Schuko-plug CEE7/7.

Industrial chairs

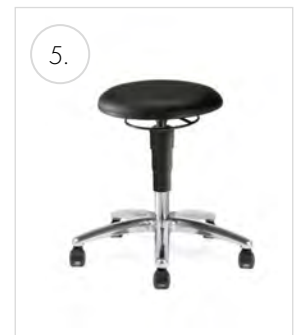
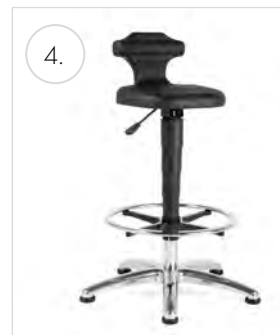
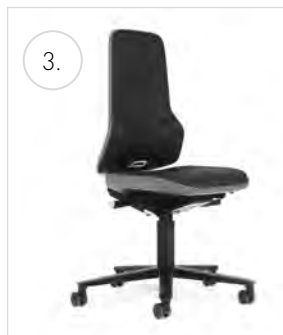
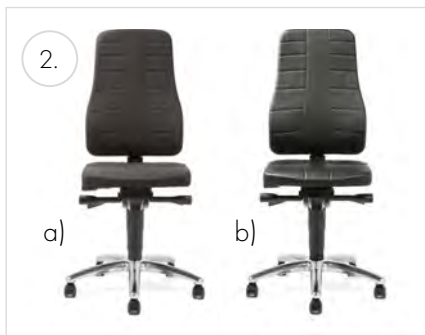

Code ESD	Description / Upholstery / Colour	Martindale	Seat height, mm*	Seat width, mm	Seat depth, mm	Backrest height, mm	Weight, kg
1. Treston Ergo chairs							
<i>With conductive soft dual-wheel safety castors with load-sensitive brakes. High version with foot ring and conductive glides.</i>							
a)	C20PU-ESD Treston Ergo 20 polyurethane black ESD		440-620	440	410	380	13,0
b)	C25PU-ESD Treston Ergo 25 polyurethane black ESD		580-850	440	410	380	15,0
c)	C30AL-ESD Treston Ergo 30 artificial leather black ESD	50.000	440-620	460	470	460	13,0
d)	C30BL-ESD Treston Ergo 30 fabric black ESD	40.000	440-620	460	470	460	13,0
e)	C35BL-ESD Treston Ergo 35 fabric black ESD	40.000	530-800	460	470	460	15,0
2. Treston Plus chairs							
<i>With conductive soft dual-wheel safety castors with load-sensitive brakes.</i>							
a)	C40AL-ESD Treston Plus 40 artificial leather black ESD	50.000	450-600	460	410-470	600	19,5
b)	C40BL-ESD Treston Plus 40 fabric black ESD	40.000	450-600	460	410-470	600	19,5
3. Neon chairs							
<i>With conductive soft dual-wheel safety castors with load-sensitive brakes.</i>							
	C50BL-G-ESD Neon 50 fabric black ESD grey strips	40.000	450-620	470	420-480	570	18,0
4. Flex standing rests							
<i>High version with foot ring and conductive glides.</i>							
	C19PU-ESD Flex 19 polyurethane black ESD		510-780	360	380	200	13,0
5. Stools							
<i>With conductive soft dual-wheel safety castors with load-sensitive brakes.</i>							
	C15AL-ESD Stool 15 artificial leather black ESD	50.000	460-630	400	400		8,0

*According to the DIN 68877, the seat height is measured from the floor to the centre of the seat with a 64-kg load. The maximum load capacity of the chairs is 120 kg.



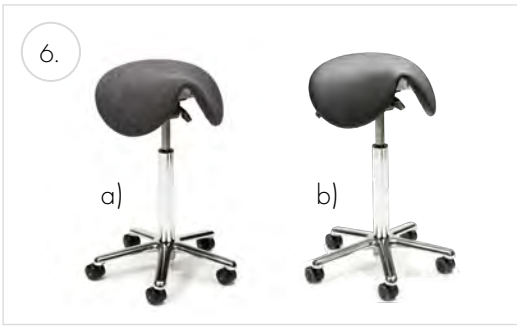

Code ESD	Description / Upholstery / Colour	Martindale	Seat height, mm*	Seat width, mm	Seat depth, mm	Backrest height, mm	Weight, kg
6. Saddle chairs							
<i>With conductive soft dual-wheel safety castors with load-sensitive brakes.</i>							
a) SADDLE G ESD	Saddle chair fabric grey ESD	> 50.000	575-820	420	350		7,0
b) SADDLE AL ESD	Saddle chair articial leather ESD black		575-820	420	350		7,0

*According to the DIN 68877, the seat height is measured from the floor to the centre of the seat with a 64-kg load. The maximum load capacity of the chairs is 120 kg.

Accessories for chairs

Product	Description	Code ESD
High glide set	Abrasion-resistant plastic glides have a large surface area and offer superb level of stability. The glides can be retrofitted to of all our chairs.	CGLIH-ESD
Soft castor set for hard floor	Dual-wheel safety castors are equipped with load-sensitive brakes, which means that the castors will brake when unloaded. As a standard, we supply soft castors for hard floors, but hard castors for soft floors need to be ordered separately.	CSCAS-ESD
Hard castor set for soft floor		CHCAS-ESD
Soft Stop&Go castor set for hard floors	In case the high chair needs to be moved around the workplace, Stop&Go castors will provide a safe solution. These castors will brake as soon as they are loaded, but when not loaded, the chair is easy to move around.	CSTOP-ESD
4D ESD armrests for Treston Ergo ESD and Treston Plus ESD	Adjustment of height, width and depth with the possibility to swivel.	ARE-ESD
4D armrests for Neon	Adjustment of height, width and depth with the possibility to swivel.	ARN-ESD
Chrome-plated foot ring	Foot ring can also be retrofitted to our lower chair models by attaching it to the chair column. Can be used on both ESD and non-ESD models. The height can be easily adjusted without any tools.	CRING

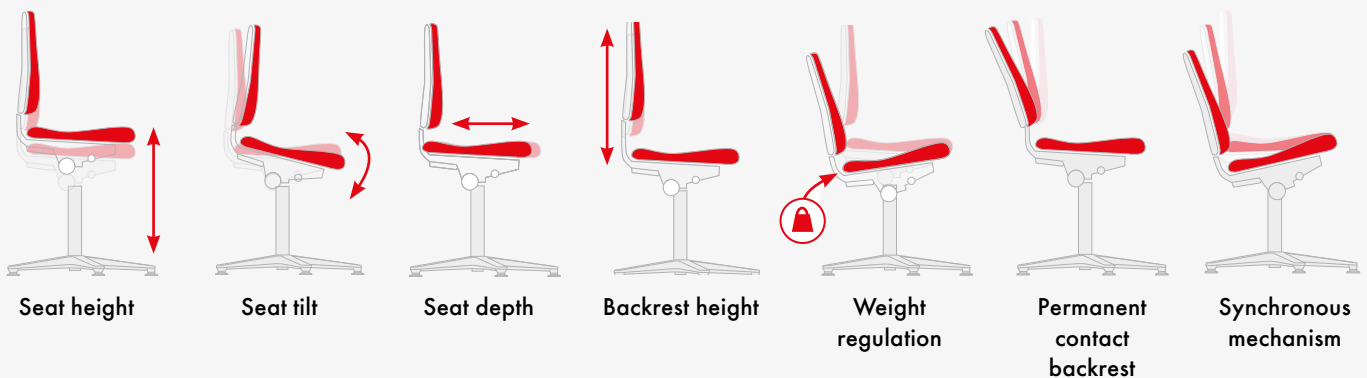

Adjustments and features	Treston Ergo	Treston Plus	Neon	Stool	Saddle chair	Flex – standing rest
Seat height	✓	✓	✓	✓	✓	✓
Seat tilt	✓	✓	✓		✓	
Seat depth		✓	✓			
Backrest height	✓	✓	✓			
Contact backrest	✓					
Synchro mechanism		✓	✓			
Arm rests as an option	✓	✓	✓			
Changeable upholstery			✓			

Trolleys



150 kg

Universal trolley WTR

Most often combined with WB workstations to provide extra storage space. A good adjustable PC station, measuring station or mobile storage, best suitable for moving equipment around the workstation.



300 kg

Industrial Multi trolley

This trolley can be equipped with shelves, tops and other module-sized accessories to fit any application, such as transportation or tool storage. The trolleys support heavy loads, but they are easy to move as well.



150 / 300 kg

Adjustable trolley TRTA

For general use wherever a good transportation and storage solution is needed. Two or four shelves available; height of the shelves can be adjusted. Mesh panels can be installed at the ends or on the sides. Also a SMD reel holder version available.



12 / 25 kg

Mobile workstation MLC

An ergonomic and versatile tool with key qualities such as light weight, small size and excellent mobility. Used wherever a laptop is needed on the go.



90 kg

Storage trolley

Simple solution for mobile storage. The shelves are fitted with rubber mats and the middle shelf is adjustable.



150 kg

Concept trolley

Most often combined with Concept and WB workstations to provide extra work and storage space. Lower shelf is integrated. Can be equipped with an additional shelf or drawer unit 30 series.



150 kg

SAP trolley

Most often combined with TP workstations to provide extra workspace. Can be equipped with a lower shelf, an extra shelf and a handle, available separately.



300 kg

Bin and cabinet trolleys

The bin and cabinet trolleys can be equipped with Treston stacking bins and bin cabinets based on own needs. Trolleys enable supplies and parts to be moved smoothly to wherever they are needed.



Universal trolley WTR

A good quality, versatile trolley, PC-station, measuring station or mobile storage trolley. Modern industrial design.

The standard trolley has 3 shelves (TS605 ESD), size 650 x 530 mm. Height adjustment of shelves is by allen-key. The vertical profiles are of aluminium. Frames are of epoxy powder coated steel: light grey RAL 7035. The worktops are of 25 mm semi-conductive laminated chipboard particle board. Four swivel castors (Ø 125 mm) two of which have brakes, overall height of castor 141 mm.



Universal trolley WTR

Name	Size W x D x H mm	Max load kg	Code ESD
1. Universal trolley	660 x 650 x 1415	150	WTR140 ESD
2. Extra shelf	530 x 650	50	TS605 ESD
3. Adjustable shelf*	530 x 650	50	TAS605 ESD
4. Bin profile	Length 525		BP50 ESD
5. Keyboard tray NT	525 x 399 x 133 (outer) 500 x 250 x 110 (inner)		NT 500 ESD

*Continuous adjustment for depth, height and angle.



Treston Industrial Multi trolley

Multi trolleys provide an ergonomic mobile workstation. Multi trolleys are available in three different widths: M500, M750 and M900. This means that all our module-sized accessories can be used with the trolleys.

The sturdy shelves can be height-adjusted and tilted. Shelves come with raised edges which keep the load in place. ESD-mats for shelves available separately.

Multi trolleys support heavy loads, but they are easy to move as well, making it simple to transport heavy equipment, such as measuring units. They are equipped with four swivel castors (Ø 125 mm), two of which have brakes.

Treston Industrial Multi trolley with adjustable shelves

Description	Module	Size W x D x H mm	Max load kg	Code ESD
1. 4 adjustable shelves	M500	540 x 760 x 1790	300	TMTH5-002-49
	M750	790 x 760 x 1790	300	TMTH7-002-49
	M900	943 x 760 x 1790	300	TMTH9-002-49
2. 2 adjustable shelves	M500	540 x 760 x 1150	300	TMTL5-002-49
	M750	790 x 760 x 1150	300	TMTL7-002-49
	M900	943 x 760 x 1150	300	TMTL9-002-49

Bottom shelf and mats for shelves, see page 61.



Treston Industrial Multi trolley with shelves

Description	Module	Size W x D x H mm	Max load kg	Code ESD
3. 4 shelves	M500	540 x 760 x 1790	300	TMTH5-001-49
	M750	790 x 760 x 1790	300	TMTH7-001-49
	M900	943 x 760 x 1790	300	TMTH9-001-49
4. 2 shelves	M500	540 x 760 x 1150	300	TMTL5-001-49
	M750	790 x 760 x 1150	300	TMTL7-001-49
	M900	943 x 760 x 1150	300	TMTL9-001-49

Bottom shelf and mats for shelves, see page 61.



1. Treston Industrial Multi trolley with perforated panels

Module	Size W x D x H mm	Max load kg	Code ESD
M750	790 x 760 x 1790	300	TMTH7-005-49
M900	943 x 760 x 1790	300	TMTH9-005-49

2. Treston Industrial Multi trolley with tilted perforated panels

Module	Size W x D x H mm	Max load kg	Code ESD
-	820 x 760 x 1860	300	TMTA-49



Industrial Multi trolley frame and accessories

- Equip your trolleys with shelves, tops and other accessories to fit any application, such as transportation or tool storage.
- All trolleys are equipped with four swivel castors (Ø 125 mm), two of which have brakes.
- Can easily be customised with a wide range of accessories, to meet individual needs.

Treston Industrial Multi trolley frame

Name	Module	Size W x D x H mm	Max load kg	Code ESD
Frame High	M500	540 x 760 x 1790	300	TMTFH5-49
Frame High	M750	790 x 760 x 1790	300	TMTFH7-49
Frame High	M900	943 x 760 x 1790	300	TMTFH9-49
Frame Low	M500	540 x 760 x 1150	300	TMTFL5-49
Frame Low	M750	790 x 760 x 1150	300	TMTFL7-49
Frame Low	M900	943 x 760 x 1150	300	TMTFL9-49



Bottom shelf

Name	Module	Size W x D x H mm	Max load kg	Code ESD
Bottom shelf M500 x 728	M500	460 x 728 x 33	100	TMTLS5-49
Bottom shelf M750 x 728	M750	710 x 728 x 33	100	TMTLS7-49
Bottom shelf M900 x 728	M900	863 x 728 x 33	100	TMTLS9-49

Mats for bottom shelves see page 61.



Steel shelf

Name	Module	Size W x D x H mm	Max load kg	Code ESD
Steel shelf M500 x 650 + brackets	M500	468 x 650 x 33	100	TMTS5-49
Steel shelf M750 x 650 + brackets	M750	718 x 650 x 33	100	TMTS7-49
Steel shelf M900 x 650 + brackets	M900	871 x 650 x 33	100	TMTS9-49

Mats for steel shelves see page 61.



Adjustable shelf, stepless tilt

Name	Module	Size W x D x H mm	Max load kg	Code ESD
Adjustable shelf M500 x 650	M500	468 x 650 x 37	100	TMTAS5-49
Adjustable shelf M750 x 650	M750	718 x 650 x 37	100	TMTAS7-49
Adjustable shelf M900 x 650	M900	871 x 650 x 37	100	TMTAS9-49

Mats for adjustable shelves see page 61.



Adjustable shelf, stepless depth and tilt

Name	Module	Size W x D x H mm	Max load kg	Code ESD
Adjustable shelf M500 x 650	M500	468 x 650 x 37	50	TMTSAS5-49
Adjustable shelf M750 x 650	M750	718 x 650 x 37	50	TMTSAS7-49
Adjustable shelf M900 x 650	M900	871 x 650 x 37	50	TMTSAS9-49

Mats for adjustable shelves see page 61.



ESD mats for shelves

Suitability	Module	Size W x D mm	Code ESD
Lower shelf TMTLS5-49	M500	455 x 723	725750-00
Lower shelf TMTLS7-49	M750	705 x 723	725747-00
Lower shelf TMTLS9-49	M900	858 x 723	725748-00
Steel shelf TMTS5-49	M500	463 x 645	725746-00
Steel shelf TMTS7-49	M750	713 x 645	725743-00
Steel shelf TMTS9-49	M900	866 x 645	725744-00
Adjustable shelf TMTAS5-49 and TMTSAS5-49	M500	428 x 600	860821-00
Adjustable shelf TMTAS7-49 and TMTSAS7-49	M750	678 x 600	860318-00
Adjustable shelf TMTAS9-49 and TMTSAS9-49	M900	831 x 600	860320-00



Industrial Multi trolley accessories

Name	Size W x D x H mm	Max load kg	Code ESD
Waste basket holder*			835 773-49
Paper roll holder*	Roll dimensions max: width 240 mm, Ø 230 mm)		860 310-49
Flow-through shelf**	718 x 835 x 61	150	890 710-49

For perforated panels, see page 39.

* fixing to upright

**including brackets



Adjustable trolley TRTA

For general use in workshops, offices, production areas and hospitals. Shelves are powder coated steel, RAL 7035 ESD, height 28 mm. All shelves are individually adjustable. The structure is light but sturdy. The end-frames of the trolley are made of round, powder coated steel tube (25 mm). Four swivel castors (Ø 125 mm), two of which have brakes.



Adjustable trolley TRTA

Name	Size W x D x H mm	Shelf size W x D mm	Max load kg	Code ESD
2-shelf trolley*	890 x 530 x 1020	800 x 430	150	TRTA4082 ESD
2-shelf trolley*	1090 x 530 x 1020	1000 x 430	150	TRTA4102 ESD
2-shelf trolley*	890 x 630 x 1020	800 x 530	150	TRTA5082 ESD
2-shelf trolley*	1090 x 630 x 1020	1000 x 530	150	TRTA5102 ESD
4-shelf trolley**	1090 x 530 x 1515	1000 x 430	300	TRTA4104 ESD
4-shelf trolley**	1090 x 630 x 1515	1000 x 530	300	TRTA5104 ESD

Max load 50 kg / shelf.

* Shelf adjustments between 200-770 mm

** Shelf adjustments between 200-1340 mm

Extra shelves TRHA

Name	Shelf size W x D mm	Max load kg	Code ESD
Extra shelf	800 x 430	50	TRHA408 ESD
Extra shelf	1000 x 430	50	TRHA410 ESD
Extra shelf	800 x 530	50	TRHA508 ESD
Extra shelf	1000 x 530	50	TRHA510 ESD

End mesh panels NET2

Name	Size W x D mm	Set	Code ESD
End mesh panel	604 x 364	Incl. 2 panels	NET2

The mesh panels can be installed at the ends of the trolley or on the sides. An angle bracket is set on the edge of the upper and lower shelf and the mesh is screwed into place. The 4-shelf trolley can hold 2 mesh panels on top of each other.

Document holder DSA4

Name	Size	Code ESD
Document holder	A4	DSA4 ESD

Semiconductive epoxy powder coated steel. Includes two magnets.

Low M-divider hoops LDH

Name	Size	Code ESD
Divider hoops	460 x 315	LDH

Steplessly adjustable. 4 pcs per set. M-shape (the lowest point 105 mm from shelf). Suitable only 430 mm deep shelves.



Low M-divider hoops LDH

Document holder

Reel holder trolley RRT

The adjustable reel holder trolley is compatible with SMD reels, and suitable for transport and stocking of them. All parts are powder coated steel, RAL 7035 ESD. The trolley has four perforated steel shelves, 1090 x 460 x 28 mm. All shelves are individually adjustable between 200-1605 mm.

The zinc plated reel racks that fit into the shelves are to be ordered separately. The structure is light but sturdy. The end-frames of the trolley are made of round, powder coated steel tube (25 mm). Four turning castors with brakes (\varnothing 125 mm). The load capacity of one shelf is 50 kg, and the load capacity of the trolley is 200 kg.

Reel holder trolley RRT

Name	Size W x D x H mm	Max load kg	Code ESD
1. Reel holder trolley	1100 x 530 x 1780	200	RRT ESD
2. Reel rack	960 x 426 x 254	50	RR ESD-Z
3. Document holder	A4		DSA4 ESD

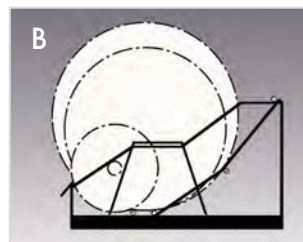
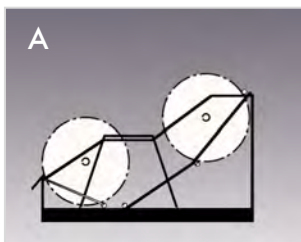
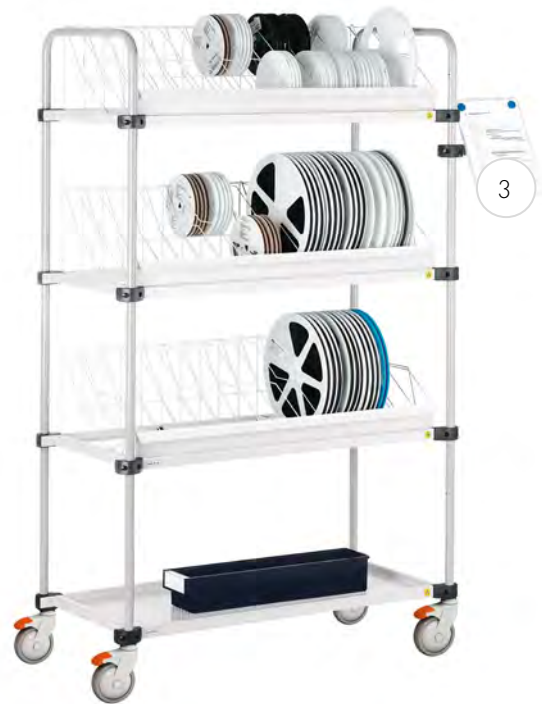

In picture A: Side view of spools and reel racks. The capacity of one rack is 30 fixed compartments for 7" spools of 60 mm width.

In picture B: Side view of spools and reel racks. The capacity of one rack is 15 fixed compartments for 13" and 15" spools of 60 mm width.



Mobile workstations

MLC mobile workstation is a light, ergonomic and easy-to-move workstation. The mobile workstation moves and turns effortlessly even in tight spaces. A laptop computer can be placed on the worktop or underneath it, in which case only the screen is visible. A wide range of accessories is available, with all the necessary supplies included.

- An ergonomic workstation that is light to move around - aluminium frame, steel legs
- Standard features include a laminated worktop and a lockable computer compartment with holes for wires
- Four swivel castors (Ø125 mm), two with brakes

MLCT mobile height adjustable work surface is a compact sized additional work surface with easy gas spring height adjustment. It is ideal for tight spaces and tasks where easy manoeuvrability is a must. Optimal for handling light loads and small sized objects. Ideal also for laptop use. Suitable for technical and EPA environments where easy ergonomics and mobility are required.

- Easy to move around due to the light construction - aluminium frame, symmetric steel legs
- Accessories available: Accessory box underneath the table top, accessories basket to the frame and a folder holder
- Four swivel castors (Ø100 mm), two with brakes



MLC mobile workstation



MLCT mobile height adjustable work surface

Mobile workstations

Name	Size W x D mm	Height mm*	Top size mm	Max load kg	Code ESD
Mobile workstation	590 x 540	800-1200	520 x 370 x 25	12	MLC 405PG ESD
Mobile height adjustable work surface	600 x 500	760-1185	580 x 490 x 25	25**	MLCT 605PG ESD

*Height is adjusted by gas spring.

** 150 N gas spring lightens the load with app. 10 kg upon lifting.

Mobile workstation accessories

Name	Description	Suitability	Code ESD
1. Binder mount	Fits a single 75 mm wide binder.	MLC, MLCT	FH1
2. LCD support arm	For the attachment of MH and MY supports. Max 22" screen.	MLC	MS
3. Accessory box ESD	With ESD shelf bin 4020-4ESD.	MLCT	AB4020-4ESD



Trolleys for additional workspace

Storage trolley is an easy solution for mobile storage, the storage trolley has an adjustable middle shelf, and the shelves are fitted with ESD or standard rubber mats.

SAP trolley provides extra workspace for the TP workbench. Lower self, extra shelf and handle are available separately. Height adjustment with allen key between 650-900 mm.

Concept trolley provides extra workspace for Concept and WB workbenches. Lower shelf is integrated. Can be equipped with an additional shelf or drawer unit 30 series. Height adjustment with allen key between 650-900 mm.



Storage trolley

Trolleys for additional workspace

Name	Size W x D x H mm	Max load kg	Code ESD
Storage trolley	650 x 450 x 775	3 x 30	852 773-49
SAP trolley	700 x 500	150	SAP507 ESD
SAP trolley	1000 x 700	150	SAP710 ESD
Lower shelf for SAP trolley	700 x 500	40	AT507 ESD
Lower shelf for SAP trolley	1000 x 700	40	AT710 ESD
Extra shelf for SAP trolley	700 x 500	40	LT507 ESD
Extra shelf for SAP trolley	1000 x 700	40	LT710 ESD
Handle for SAP trolley	depth 500		PUSH50
Handle for SAP trolley	depth 700		PUSH70
Concept trolley	500 x 700 x 650-900	150	CONT705-49
Extra shelf for Concept trolley	400 x 500	25	CONTS504-49
Drawer unit 30/15	300 x 454 x 150	10	859 330-49
Drawer unit 30/22	300 x 454 x 220	10 / drawer	859 340-49
Drawer unit fastening set			890 653-49

All the light-duty trolleys are equipped with four swivel castors (ø 100 mm), two of which have brakes.



SAP trolley with AT lower shelf, LT extra shelf and PUSH handle



Concept trolley, extra shelf and drawer unit 30/15

Cabinet trolley for storage cabinets

- Double-sided ESD-protected trolley for small-part storage cabinets
- Steel frame and fixed bottom shelf powder-coated with a semiconductive ESD paint (light grey, RAL 7035).
- Maximum eight small-parts cabinets, 4 on each side, to be ordered separately
- Four swivel ESD-castors (Ø 100 mm), two with brakes.
- Module M750, all the upright tube accessories are available



Cabinet trolley BT-550B ESD

Name	Size W x D x H mm	Max load kg	Code ESD
Cabinet trolley	790 x 760 x 1770	300	BT-550B ESD

Height of the fixing rails can be adjusted easily without tools. Height adjustable ergonomic push handle.

Suitability

Type	Number of drawers	Dimensions W x D x H mm
551-4ESD	48 pcs	69 x 170 x 40
554-4ESD	24 pcs	92 x 170 x 62

Stacking bin trolley

- Double-sided ESD-protected trolley for stacking bins
- Steel frame and fixed bottom shelf powder-coated with a semiconductive ESD paint (light grey, RAL 7035).
- Up to 112 stacking bins can be attached to one trolley, must be ordered separately
- Height adjustable ergonomic push handle
- Sixteen step-by-step height adjustable bin rails, eight bin rails per side, length of bin rails 742mm
- Height of the bin rails can be adjusted easily without tools
- Four swivel ESD-castors (Ø 100 mm), two with brakes
- Load capacity for bin rail 50 kg, for trolley 300 kg
- Module M750, all the upright tube accessories are available.



Trolley BT-170B ESD

Name	Size W x D x H mm	Max load kg	Code ESD
Stacking bin trolley	790 x 760 x 1770	300	BT-170B ESD

Suitability

Stacking bin	Quantity/rail	Max. quantity/stand
1015	7 pcs	112 pcs
1520	5 pcs	80 pcs
1525	5 pcs	80 pcs
1930	4 pcs	64 pcs

Drawer units



Light steel cabinet LMC

These steel cabinets are an ideal way of providing individual secure storage for your staff. Drawers are mounted on telescopic ball race slides. Four cabinet sizes, including one drawer/cupboard combination.



Drawer units 30 and 35

These drawer units are fastened under a workbench to provide storage space. Choose from single drawer, two drawers or drawer cabinet. If additional drawers are needed, they can be easily attached to each other. The drawers can be locked to protect the contents.



Drawer unit 45

Choose from two frame heights: 56 or 66 cm, with a plinth for a stand alone solution or with castors for a trolley version. The drawer unit 45 can also be attached under the worktop. All the drawer units have central locking.

Light steel cabinet **LMC**

These steel cabinets are an ideal way of providing individual secure storage for your staff. Drawers are mounted on telescopic ball race slides. Four cabinet sizes, including one drawer/cupboard combination. The cabinet frames are epoxy powder coated steel; drawer fronts are composite board with aluminium handles. Mount on benches with brackets (included).

Suitable for **WB/TP/TPH** workbenches and **SAP/WTR** trolleys



Light steel cabinet, load capacity 15 kg/drawer, 70 % opening

Code ESD	LMC01 ESD	LMC02 ESD	LMC04 ESD	LMC04D ESD
Outer dims W x D x H mm	370 x 460 x 135	370 x 460 x 245	370 x 460 x 455	370 x 460 x 455
Includes drawers (outer height mm)	1 x 100	2 x 100	4 x 100	1 x 100 + cupboard, height 300 mm, open to right

Internal drawer dimensions: 278 x 438 x 75 mm

Cover LMCK2

Description	Code ESD
Needed for mounting cabinets to WB benches and WTR trolley.	LMCK2

Drawer units **30 and 35**

These drawer units are fastened under a workbench to provide storage space. Choose from single drawer, two drawers or drawer cabinet. If additional drawers are needed, they can be easily attached to each other. The drawers can be locked to protect the contents.

Drawer cabinet 35/47 is suitable for storing upright folders.



Drawer units 30 and 35, load capacity 10 kg/drawer, 80 % opening

	30/15	30/22	35/47
Code ESD	859 330-49	859 340-49	860 972-49
Outer dims W x D x H mm	300 x 454 x 150	300 x 454 x 220	350 x 470 x 470
Includes drawers (outer height mm)	1 x 150	2 x 110	1 x 110 + cupboard, height
Internal drawer dimensions:	255 x 400 x 120 mm	255 x 400 x 75 mm	300 x 400 x 70 mm

Fastening sets for drawer unit 30 and 35 (should be selected according to the type of the workbench)

Depth	600 mm	700 mm	750 mm	800 mm	900 mm
Concept, allen key adjustable	890 653-49	-	890 653-49	-	890 653-49
Concept, hand crank adjustable	-	-	890 653-49	-	890 653-49
Concept, motor adjustable	-	-	854 463-49	-	854 463-49
TED	-	-	-	855 057-49	-
TP / TPH	-	855 054-49	-	-	855 054-49
WB	-	-	-	855 054-49	-

Not adapted to Concept handcrank and motor adjustable bench (depth 600 mm).

Drawer unit 45

Centrally locked high quality steel drawer units for storage of tools and small components. Mounted under workbenches with brackets. Also available with castors as a trolley version. Drawer units are epoxy powder coated in grey, RAL 7035. Central locking. Full width drawer handle in anodised aluminium. Smooth and quiet telescopic ball-race runners with 100 % opening of the drawers. Load-bearing capacity is 60 kg per drawer. Our drawer units are suitable for use in EPAs. The mobile trolleys are available in both ESD and non- ESD versions.

Drawers open
100% and their
load capacity is
60 kg.

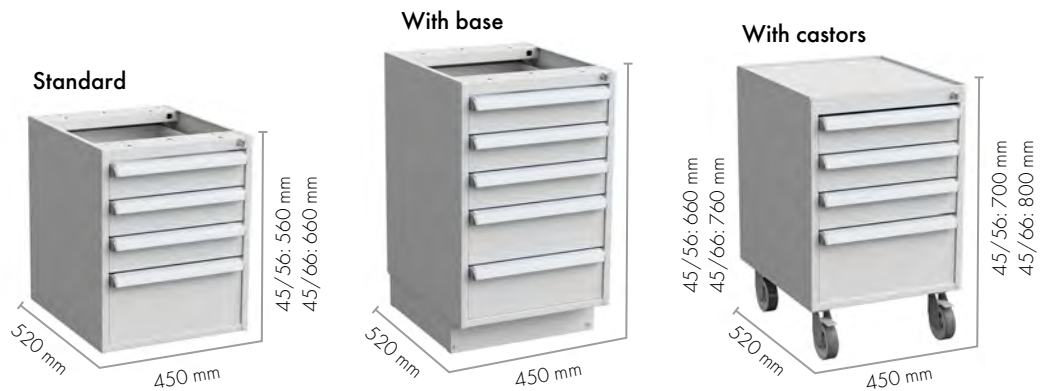

Load capacity 150 kg, 4 swivel castors (ø 100 mm), 2 with brakes. The trolley version comes with a rubber mat that stops items from sliding on the surface.

- Choose the drawer unit according to your needs; with castors, base or no base.
- Drawer units with castors are also available as non ESD-versions (code 41 instead of 49).

Internal drawer dimensions mm	
Outer height mm	Inner height mm
100	90
150	140
200	190
300	290

1. Drawer unit 45/14-1

Drawers	Code ESD
100 x 1	Standard 603 49 001

2. Drawer unit 45/26-1

Drawers	Code ESD
100 x 2	Standard 604 49 001

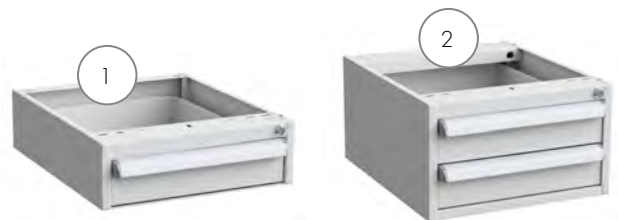

3. Drawer unit 45/56-2

Drawers	Code ESD Standard	Code ESD With base	Code ESD With castors
100 x 2, 150 x 2	606 49 102	606 49 202	606 49 302



4. Drawer unit 45/56-3

Drawers	Code ESD Standard	Code ESD With base	Code ESD With castors
100 x 3, 200 x 1	606 49 103	606 49 203	606 49 303



5. Drawer unit 45/66-1

Drawers	Code ESD Standard	Code ESD With base	Code ESD With castors
100 x 6	607 49 101	607 49 201	607 49 301

6. Drawer unit 45/66-2

Drawers	Code ESD Standard	Code ESD With base	Code ESD With castors
100 x 3, 150 x 2	607 49 102	607 49 202	607 49 302

7. Drawer unit 45/66-6

Drawers	Code ESD Standard	Code ESD With base	Code ESD With castors
100 x 2, 200 x 2	607 49 106	607 49 206	607 49 306

8. Drawer unit 45/66-7

Drawers	Code ESD Standard	Code ESD With base	Code ESD With castors
200 x 3	607 49 107	607 49 207	607 49 307



Additional drawer units 45/56

	45/56-1	45/56-4	45/56-7	45/56-10	45/56-11
Standard	606 49 101	606 49 104	606 49 107	606 49 110	606 49 111
With base	606 49 201	606 49 204	606 49 207	606 49 210	606 49 211
With castors	606 49 301	606 49 304	606 49 307	-	-
100	x 5	x 1	-	x 2	-
150	-	-	x 2	-	-
200	-	x 2	x 1	-	x 1
300	-	-	-	x 1	x 1

Additional drawer units 45/66

	45/66-3	45/66-4	45/66-5	45/66-12	45/66-13	45/66-14	45/66-15
Standard	607 49 103	607 49 104	607 49 105	607 49 112	607 49 113	607 49 114	607 49 115
With base	607 49 203	607 49 204	607 49 205	607 49 212	607 49 213	607 49 214	607 49 215
With castors	607 49 303	607 49 304	607 49 305	-	-	-	-
100	x 1	-	x 4	x 3	-	x 1	-
150	x 2	x 4	-	-	x 2	-	-
200	x 1	-	x 1	-	-	x 1	-
300	-	-	-	x 1	x 1	x 1	x 2

Cabinet 45/56, door right

	w/o lock	with lock
Standard	606 49 105	606 49 108
With plinth	606 49 205	606 49 208
With castors	606 49 305	606 49 308

Cabinet 45/56, door left

	w/o lock	with lock
Standard	606 49 106	606 49 109
With plinth	606 49 206	606 49 209
With castors	606 49 306	606 49 309



Cabinets include one bottom shelf and one adjustable shelf, shelf load capacity 50 kg.

Drawer cabinet 45/66, door right

drawer 1 x 100	w/o lock	with lock
Standard	607 49 108	607 49 110
With plinth	607 49 208	607 49 210
With castors	607 49 308	607 49 310

Drawer cabinet 45/66, door left

drawer 1 x 100	w/o lock	with lock
Standard	607 49 109	607 49 111
With plinth	607 49 209	607 49 211
With castors	607 49 309	607 49 311



Cabinets include one bottom shelf and one adjustable shelf, shelf load capacity 50 kg.

Fastening sets for drawer unit 45 (should be selected according to the type of the workbench)

Depth	600 mm	700 mm	750 mm	800 mm	900 mm
Concept, allen key adjustable	890 653-49	-	890 653-49	-	890 653-49
Concept, hand crank adjustable	-	-	890 653-49	-	890 653-49
Concept, motor adjustable	-	-	854 463-49	-	854 463-49
TP / TPH	-	855 055-49*	-	-	855 055-49*
WB	-	-	-	855 055-49*	-

Not adapted to Concept handcrank and motor adjustable bench (depth 600 mm).

* Standard drawer unit models include fastening set. For drawer unit models with plinth the fastening set 855 055-49 is available only upon order.

For heavy loads we recommend adding a plinth or castors to the drawer unit.

Cover

Description	Code
Needed for mounting drawer unit 45 to WB benches.	855 060-49



Drawer interiors

Divider set 1

Model	Code ESD
Drawer 45/100	872 991-49
Drawer 45/ 150 and 45/200	872 996-49
4 x horizontal dividers 375	

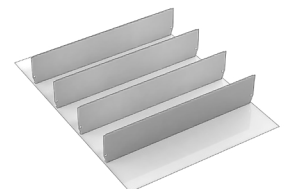
**Divider set 2**

Model	Code ESD
Drawer 45/100	872 992-49
Drawer 45/ 150 and 45/200	872 997-49
1 x vertical divider, 8 x divider plate 185	

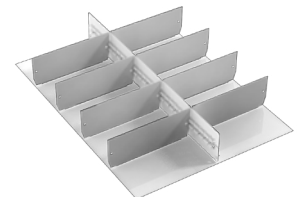
**Divider set 3**

Model	Code ESD
Drawer 45/100	872 993-49
Drawer 45/ 150 and 45/200	872 998-49
1 x vertical divider, 4 x divider plate 125, 4 x divider plate 250	

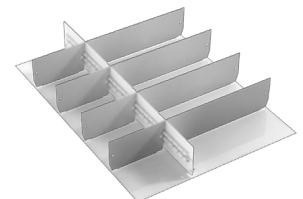
**Divider set 4**

Model	Code ESD
Drawer 45/100	872 994-49
Drawer 45/ 150 and 45/200	872 999-49
2 x vertical divider, 12 x divider plate 125	

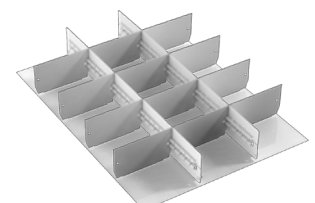

Storage systems

FiFo Flow Rack



FiFo Flow Rack

Name	Suitability of bins	Module	Size W x D x H mm	Max load kg	Code ESD
1 FiFo Flow Rack	24 pcs Treston stacking bins 1940 or similar.	M900	933 x 805 x 1860	700	TFR900-49
	24 pcs Treston stacking bins 3040, 24 pcs 300 x 400 euroboxes or similar.	M1350	1385 x 805 x 1860	700	TFR1350-49
2 FiFo Flow Rack, rear extension	24 pcs Treston stacking bins 1940 or similar.	M900	933 x 735 x 1860	700	TFR900RE-49
	24 pcs Treston stacking bins 3040, 12 pcs 300 x 400 euroboxes or similar.	M1350	1385 x 735 x 1860	700	TFR1350RE-49
3 FiFo Flow Rack, side extension	24 pcs Treston stacking bins 1940 or similar	M900	933 x 805 x 1860	700	TFR900SE-49
	24 pcs Treston stacking bins 3040, 24 pcs 300 x 400 euroboxes or similar.	M1350	1385 x 805 x 1860	700	TFR1350SE-49
4 FiFo Flow Rack, side-rear extension	24 pcs Treston stacking bins 1940 or similar.	M900	933 x 735 x 1860	700	TFR900SRE-49
	24 pcs Treston stacking bins 3040, 12 pcs 300 x 400 euroboxes or similar.	M1350	1385 x 735 x 1860	700	TFR1350SRE-49

Rack includes 3 roller tops which are adjustable without any tools. Each roller top includes 8 pcs roller profiles and 3 pcs guide plates.

Many other bin size options are suitable by adding or removing roller profiles and guide plates.

FiFo Flow Rack with steel shelves

Name	Suitability of bins	Module	Size W x D x H mm	Max load kg	Code ESD
FiFo Flow Rack, steel shelves	24 pcs Treston stacking bins 1940 or similar.	M900	933 x 805 x 1860	700	TFR900SS-49
	32 pcs Treston stacking bins 3040, 300 x 400 euroboxes or similar. Alternatively 48 pcs Treston stacking bins 1940 or similar.	M1350	1385 x 805 x 1860	700	TFR1350SS-49

The rack includes 4 steel shelves which are adjustable.





FiFo Flow Rack accessories

Name	Description	Module	Size W x D x H mm	Max load kg	Code ESD
1 Roller top	An extra roller top increases the space for the bins in the FiFo flow rack. Includes fixing brackets.	M900	852 x 766 x 105	220	TFRRT900-49
		M1350	1279 x 766 x 105	220	TFRRT1350-49
2 Roller top, rear extension	An extra roller top of rear extension increases the space for the bins in rear extension FiFo flow rack. Includes fixing brackets.	M900	852 x 766 x 105	220	TFRRT900RE-49
		M1350	1279 x 766 x 105	220	TFRRT1350RE-49
3 Additional shelf for FiFo Flow Rack with steel shelves	An extra steel shelf increases the space for the bins in steel shelves version of FiFo flow rack. Includes fixing brackets.	M900	852 x 789 x 53	220	TFRAS900-49
		M1350	1310 x 789 x 52	220	TFRAS1350-49
4 Roller profile set, 4 pcs Guide plate set, 3 pcs	Extra roller profiles and guide plates allow you to increase storage space by using smaller bins in your FiFo flow rack.		29 x 734 x 37		TFRRS-49
			2 x 718 x 70		TFRGP-49
5 Perforated panel set, 2 pcs (left, right)	With perforated panels you can cover both side of FiFo flow rack. With the panel hooks you can use the side panels easily as tool storage as well.		15 x 736 x 812		TFRPP-49
6 Castor set ESD	Castor set for Treston FiFo Flow Rack M900 ESD				TFR900CS-49
	Castor set for Treston FiFo Flow Rack M1350 ESD				TFR1350CS-49

All Treston accessories available for upright tubes are suitable for FiFo Flow Rack.



Extendable with rear and side modules – with as many modules as needed.



Watch the 2 min animation showcasing the features:

<https://vimeo.com/427987809>



Shelving system

Shelving system can be built as a combination of cabinets and shelves and you can use it as a space divider. The storage system is available in two standard heights: 200 cm and 240 cm and two widths: 80 cm and 100 cm.

1. Standard parts

Name	Size W x D x H mm	Code ESD
Standard part 80/30/200	824 x 300 x 2000	C 313 49 001P
Standard part 80/40/200	824 x 400 x 2000	C 314 49 001P
Standard part 100/30/200	1024 x 300 x 2000	C 313 49 002P
Standard part 100/40/200	1024 x 400 x 2000	C 314 49 003P
Standard part 100/50/200	1024 x 500 x 2000	C 315 49 001P
Standard part 100/60/200	1024 x 600 x 2000	C 316 49 001P
Standard part 80/40/240	824 x 400 x 2400	C 314 49 002P
Standard part 100/40/240	1024 x 400 x 2400	C 314 49 004P
Standard part 100/50/240	1024 x 500 x 2400	C 315 49 002P
Standard part 100/60/240	1024 x 600 x 2400	C 316 49 002P

2. Extension parts

Name	Size W x D x H mm	Code ESD
Extension part 80/30/200	804 x 300 x 2000	C 323 49 001P
Extension part 80/40/200	804 x 400 x 2000	C 324 49 001P
Extension part 100/30/200	1004 x 300 x 2000	C 323 49 002P
Extension part 100/40/200	1004 x 400 x 2000	C 324 49 003P
Extension part 100/50/200	1004 x 500 x 2000	C 325 49 001P
Extension part 100/60/200	1004 x 600 x 2000	C 326 49 001P
Extension part 80/40/240	804 x 400 x 2400	C 324 49 002P
Extension part 100/40/240	1004 x 400 x 2400	C 324 49 004P
Extension part 100/50/240	1004 x 500 x 2400	C 325 49 002P
Extension part 100/60/240	1004 x 600 x 2400	C 326 49 002P

All standard and extension parts include 6 shelves.



Load capacity 1000 kg/part

width 824 mm

150 kg/shelf

width 1024 mm

150 kg/shelf



The W x D x H rule

All our dimensions follow a WDH rule, where the first dimension is the width (W), the middle the depth (D), and the last the height (H).

Industrial cabinets

1. 80/200 C 309 49 001

Qty	Name	Size W x D x H mm	Code ESD
1	Cabinet frame 80/200	800 x 425 x 2000	C 309 49 000
4	Steel shelf 80	730 x 396 x 32	854 345-49

2. 80/100 C 305 49 001

Qty	Name	Size W x D x H mm	Code ESD
1	Cabinet frame 80/100	800 x 425 x 1000	C 305 49 000
2	Steel shelf 80	730 x 396 x 32	854 345-49



Shelving cabinets

Shelving cabinets are made of epoxy powder coated steel. The frames and doors are painted with light grey RAL 7035. The cabinet has sturdy double leaf-doors, flush fitting handle with two keys. Shelving cabinet can be moved with fork lift. There are leveling screws under the cabinet for adjusting the cabinet straight. The shelving cabinets are pre-assembled.



Move with a pallet truck

The cabinet can be moved with a pallet truck or a forklift when it is empty. Cabinets are equipped with adjustment screws.



Shelving cabinets (includes 2 or 4 shelves)

Name	Size W x D x H mm	Max load kg	Code ESD
Shelving cabinet 100/40/200	1030 x 430 x 2010	600	SC10040200-49
Shelving cabinet 100/50/200	1030 x 530 x 2010	600	SC10050200-49
Shelving cabinet 100/60/200	1030 x 630 x 2010	600	SC10060200-49
Shelving cabinet 100/40/100	1030 x 430 x 1040	300	SC10040100-49
Shelving cabinet 100/40/100	1030 x 530 x 1040	300	SC10050100-49
Additional shelf	1000 x 400	150	852 231-49
Additional shelf	1000 x 500	150	852 185-49
Additional shelf	1000 x 600	150	852 187-49
Perforated panel 1000	983 x 500		852 145-49
Drawer 100/100, for 400 deep cabinet	920 x 345 x 107	30	834 513-49
Drawer 100/100, for 500 deep cabinet	920 x 345 x 107	30	834 514-49

Combination name

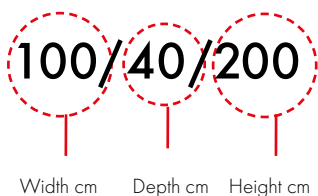

Load capacity

150 kg/shelf



600 kg/cabinet



Small parts storage cabinets

Our product range features four different, small parts storage cabinets for ESD-protected storage of sensitive components. The style of these storage cabinets represents the latest in industrial design. These cabinets can be wall hung, mounted on turntables, or stood on a work top. Two frames of different heights are available, 290 and 550 mm.

A storage cabinet consists of a frame, shelves, small drawers and labels. The frame is made of semiconductive polypropylene (PP), the drawers of semiconductive polystyrene (PS), and the shelves of galvanised steel. Small drawers are detailed on page 79. Cabinets come as standard with a connector for a ground-connection cord (not provided). Accessories: cross dividers made of semiconductive polystyrene (PS).



Contains cabinets (quantity x type)	24 x L-61-4ESD	12 x L-64-4ESD	48 x L-61-4ESD	24 x L-64-4ESD
Cabinet dimensions W x D x H	69 x 170 x 40 mm	92 x 170 x 62 mm	69 x 170 x 40 mm	92 x 170 x 62 mm
Frame dimensions W x D x H	310 x 180 x 290 mm	310 x 180 x 290 mm	310 x 180 x 550 mm	310 x 180 x 550 mm
Cross dividers, ordered separately (quantity/drawer)	V-1-4ESD (5 pcs)	V-4-4ESD (5 pcs)	V-1-4ESD (5 pcs)	V-4-4ESD (5 pcs)
Code ESD	291-4ESD	294-4ESD	551-4ESD	554-4ESD

+

Cabinet trolley on page 65.

This assembly holds 8 cabinets, which must be ordered separately.



Spacemisers for small parts storage cabinets

Thousands of sensitive components and other parts can be kept in proper order using an ESD-protected spacemiser. The assembly holds 12 storage cabinets from series 551/554 ESD (ordered separately). Owing to its robust base and divider shelf system, the spacemiser retains its cabinets firmly in place and has a load capacity of 400 kg.

Mounted on a ball-bearing base, the unit can be effortlessly rotated for ease of use. A single assembly can offer storage for up to 3456 different items on a floor area of only 0.25 sqm. Earthing via a 1 megaohm protective resistor. The unit is easy to assemble.

Spacemiser

Size W x D x H mm	Max load kg	Code ESD
500 x 500 x 1730*	400	12-550 ESD

*The overall dimensions of a completely assembled unit.

Bench top spacemiser PTP-5 ESD

This unit holds two small parts storage cabinets, 290 mm or 550 mm in height, with their backs facing each other – cabinets must be ordered separately. The assembly comprises a ball-bearing base and a bottom plate. Includes a ground-connection cord.

Bench top spacemiser

Size W x D x H mm*	Max load kg	Code ESD
360 x 310 x 300 mm (series 290)*	50	PTP-5 ESD
360 x 310 x 560 mm (series 550)*		

*The overall dimensions of a completely assembled unit.



Spacemiser



ESD bench top spacemiser



Storage bin cabinets

Designed for the electronics industry. These cabinets can be wall hung or mounted on turntables, or stood on a work top. This product is available in two depths, 300 and 400 mm.

This product includes a frame, bins and labels with protective shields. The steel frame has a semiconductive ESD powder-coat finish in grey, the bins are of semiconductive polypropylene (PP). Backstops hold the bins when fully extended. Details on the shelf bins can be found on page 80. Cabinets come with a connector for a ground-connection cord as standard. Accessories: cross dividers made of semiconductive polypropylene (PP).



Contains bins (quantity x type)	8 x 3020-4ESD	16 x 3010-4ESD	8 x 4020-4ESD	16 x 4010-4ESD
Bin dimensions W x D x H	186 x 300 x 82 mm	92 x 300 x 82 mm	186 x 400 x 82 mm	92 x 400 x 82 mm
Frame dimensions W x D x H	400 x 300 x 395 mm	400 x 300 x 395 mm	400 x 400 x 395 mm	400 x 400 x 395 mm
Cross dividers, ordered separately (quantity/drawer)	D-20-4ESD (4 pcs)	D-10-4ESD (4 pcs)	D-20-4ESD (6 pcs)	D-10-4ESD (6 pcs)
Code ESD	0830 ESD	1630 ESD	0840 ESD	1640 ESD

Spacemisers for storage bin cabinets

A free-standing spacemiser storage system for the electronics industry. The robust, ball-bearing base has a load capacity of 800 kg. These assemblies offer storage for up to 1792 different items on a floor area of only 0.64sqm. The unit includes a ball-bearing base and shelves in 4 layers. Earthing via a 1 megaohm protective resistor. Easy to assemble – no tools required.

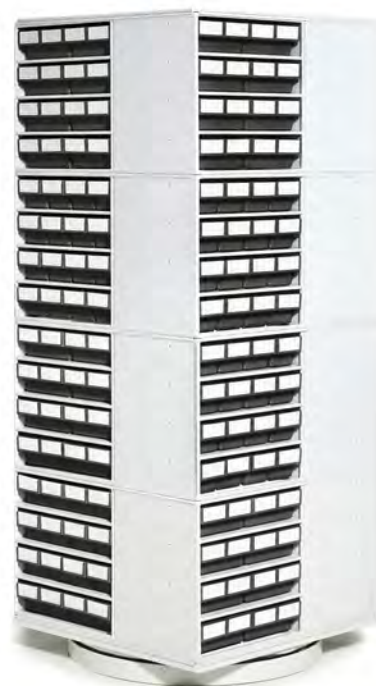

Spacemiser

Name	Size W x D mm	Max load kg	Code ESD
Spacemiser*	700 x 700 x 1680	800	16-300 ESD
Spacemiser**	800 x 800 x 1680	800	16-400 ESD

*This unit holds 16 storage bin cabinets from series 0830/1630 ESD (ordered separately).

**This unit holds 16 storage bin cabinets from series 0840/1640 ESD (ordered separately).

High density storage cabinets

High density storage cabinets provide a lot of ESD-protected storage in a very small foot print. These cabinets can be equipped with castors when necessary.

This product includes a frame, bins and labels with protective shields. The steel frame has a semiconductive ESD powder-coat finish in light grey (RAL 7035). The shelves are made of galvanised steel and the bins of semiconductive polypropylene (PP). Backstops hold the bins when fully extended. Adjustable feet are provided for fine levelling of the cabinet on uneven surfaces. The load capacity of a cabinet is 240 kg and a single shelf is 30 kg. Earthing via a 1 megaohm protective resistor. Bin dimensions can be found on page 80. Accessories: cross dividers and a castor set.



2440 ESD

4840 ESD

High density storage cabinets

	Code ESD	Code ESD
	2440 ESD	4840 ESD
Includes drawers (type/quantity)	4020 (24 pcs)	4010 (48 pcs)
Frame depth	410	410
width	605	605
height	870	870
Cross dividers, ordered separately (quantity/drawer)	D-20-4ESD (6 pcs)	D-10-4ESD (6 pcs)

Castor set

Name	Size mm	Max load kg	Code ESD
Castor set, 4 pcs	Ø 100	150	PS-LH ESD



2440 ESD + PS-LH ESD

ESD bins

1. Shelf bins

External dimensions W x D x H mm	Capacity, litres	Quantity, package	Cross divider (ordered separately)	Code ESD
92 x 300 x 82	1,3	30	D-10-4ESD	3010-4ESD
92 x 400 x 82	1,9	30	D-10-4ESD	4010-4ESD
92 x 500 x 82	2,4	30	D-10-4ESD	5010-4ESD
132 x 400 x 100	3,2	20	D-15-4ESD	4015-4ESD
132 x 500 x 100	4,5	20	D-15-4ESD	5015-4ESD
132 x 600 x 100	5,5	15	D-15-4ESD	6015-4ESD
186 x 300 x 82	3,0	15	D-20-4ESD	3020-4ESD
186 x 400 x 82	4,2	15	D-20-4ESD	4020-4ESD
186 x 500 x 82	5,3	15	D-20-4ESD	5020-4ESD
186 x 600 x 82	6,5	15	D-20-4ESD	6020-4ESD

Made of semiconductive polypropylene (PP). A full-width label with a protective shield is easy to keep clean and change when necessary – such shields and labels are not conductive.

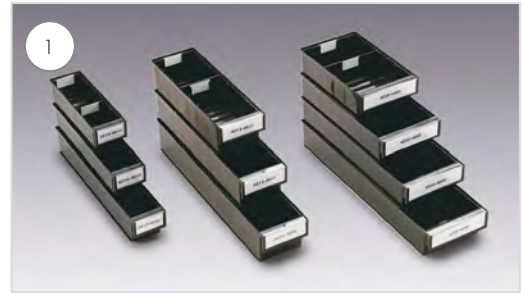

2. Small drawers

External dimensions W x D x H mm	Capacity, litres	Quantity, package	Cross divider (ordered separately)	Code ESD
69 x 170 x 40	0.2	96	V-1-4ESD	L-61-4ESD
92 x 170 x 62	0.7	45	V-4-4ESD	L-64-4ESD

Made of semiconductive polystyrene (PS). A spare part for small parts storage cabinets; see page 76.

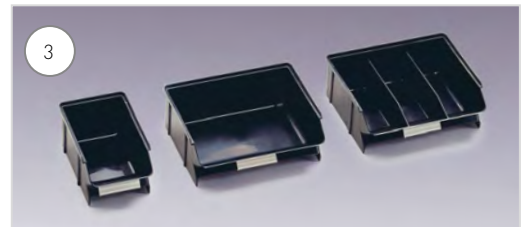

3. Picking bins

External dimensions W x D x H mm	Capacity, litres	Quantity, package	Includes	Code ESD
99 x 160 x 70	1.1	60		30-1L-4ESD
198 x 160 x 70	2.2	30		30-2L-4ESD
198 x 160 x 70	2.2	30	2 fixed dividers	30-23L-4ESD

Ideal for highly repetitive picking tasks such as typesetting. Made of semiconductive polystyrene (PS).



4. Storage bins

External dimensions W x D x H mm	Capacity, litres	Quantity, package	Code ESD
185 x 490 x 250	12.0	12	1949-4ESD
310 x 490 x 250	22.0	12	3149-4ESD

Made to order. Request a quotation.

Ideal for in-house material flows within factories and warehouses. Semiconductive polypropylene (PP).



5. Stacking bins

External dimensions W x D x H mm	Capacity, litres	Quantity, package	Cross divider (ordered separately)	Labels + shields (ordered separately)	Code ESD
105 x 165 x 75	0.6	60	–	E-10	1015-4ESD
149 x 192 x 105	1.5	45	–	E-15	1520-4ESD
149 x 250 x 130	2.7	30	V-14	E-15	1525-4ESD
186 x 300 x 156	5.0	24	V-19	E-20	1930-4ESD
186 x 400 x 156	7.2	24	V-19	E-20	1940-4ESD
186 x 510 x 182	9.6	12	V-195	E-20	1950-4ESD*
310 x 400 x 156	11.9	12	V-30	E-20	3040-4ESD*
310 x 500 x 182	17.8	8	V-30	E-20	3050-4ESD*

*Made to order. Request a quotation.

Made of semiconductive polypropylene (PP). Dividers coated with a semiconductive ESD paint and labels with protective covers as an accessory. Labels and protective covers are not conductive.

Semiconductive polystyrene = PS

- surface resistance 103...106 Ω
- volume resistivity 103...106 Ω
- temperature tolerance -40...+ 55°C

Semiconductive polypropylene = PP

- surface resistance 103...106 Ω
- volume resistivity 103...106 Ω
- temperature tolerance -20...+ 70°C

Drawer unit spare parts

Name	Size W x D x H	Compatibility	Code ESD
Cover with an ESD mat, assembled	450 x 518 x 14	45 drawer unit	W872 107-49
Cover without mat	450 x 518 x 14	45 drawer unit	872 107-49
ESD mat, light grey	445 x 513	45 drawer unit cover	836 750-00
Shelf for cabinet version		45 drawer unit	872 043-49
Bracket pair for the shelf		45 drawer units	872 045-51
Castor set Ø 100 ESD		45 drawer units	852 774-00

Drawer interior spare parts for drawer unit 45

Name	Compatibility	Code ESD
Vertical divider	45/100 drawer	872 300-49
Vertical divider	45/150 and 45/200 drawers	872 301-49
Divider plate L=125	45/100 drawer	872 302-49
Divider plate L=185	45/100 drawer	872 303-49
Divider plate L=250	45/100 drawer	872 304-49
Divider plate L=375	45/100 drawer	872 305-49
Divider plate L=125	45/150 and 45/200 drawers	872 306-49
Divider plate L=185	45/150 and 45/200 drawers	872 307-49
Divider plate L=250	45/150 and 45/200 drawers	872 308-49
Divider plate L=375	45/150 and 45/200 drawers	872 309-49
Divider holder set for drawer interiors (incl. 12 pcs)		853 003-00

Castors

Name	Compatibility	Screw	Code ESD
Castor set Ø 100 ESD	45 drawer units, Storage trolley	M10	852 774-00
Castor set Ø 100 ESD	Concept and TP benches	M12	860 429-00
Castor set Ø 100 ESD	WB bench, TED desk		LCS100 ESD
Castor set Ø 125 ESD	TRTA trolley		LCS125 ESD
Swivel castor Ø125 ESD, brake	Treston Industrial Multi trolley ESD	M10	10022-00
Swivel castor Ø125 ESD	Treston Industrial Multi trolley ESD	M10	10020-00
Castor set Ø 50 ESD	Transport skate ESD	M10	853 175-00

Arm adapters for MH/MA/MA2/MA3

Profile type	Workbench model	MH	MA	MA2	MA4
C-profiles	TPH	AS2	AS2	AS2	AS4C
Upright profiles	Concept, TP, TED	AS2	AS2	AS2	AS4

Arm adapters for Concept/TP/TED accessories with arms (for example 93049002P)

Profile type	Workbench / trolley model	40 mm arm	60 mm arm
C-profiles	TPH	-	E824 081-49
AL2X aluminum profiles	WB	890 524-49	890 525-49
Aluminum profiles	WTR	E821 573-49	E821 572-49

Spare parts labels for ESD plastic bins, dividers and small drawers

Name	Size W x H mm	Min. order quantity	Compatibility	Code
Label for bin	82 x 41	15 pcs	3010-4ESD, 4010-4ESD, 5010-4ESD	1868
Label for bin	12 x 41	15 pcs	4015-4ESD, 5015-4ESD, 6015-4ESD	3532
Label for bin	176 x 41	15 pcs	3020-4ESD, 4020-4ESD, 5020-4ESD, 6020-4ESD	1123
Label for bin	77 x 26	12 pcs	1949-4ESD, 3149-4ESD	1789
Label for cross divider	59 x 30	20 pcs	D-10-4ESD, D-15-4ESD, D-20-4ESD	1792
Label for small drawer	42 x 15,5	95/ A4	30-1L-4ESD, 30-2L-4ESD, 30-23L-4ESD	3195
Label for small drawer	65,5 x 17	12 pcs	L-61-4ESD	1119
Label for small drawer	86,5 x 25	12 pcs	L-64-4ESD	1120

Download **free eBooks or a White paper**



6-point checklist for creating and maintaining ESD-protected areas

This informational e-book lists 6 steps for setting up an ESD-protected area in your workplace. No matter whether you need just one workbench or a full-scale production line, the same principles apply to ensuring that ESD protection functions as it should.



White Paper: Comprehensive Guide on How to Measure ESD

This comprehensive guide covers everything from the ESD measuring equipment to methods for measuring in your workspace. We'll walk you through the ESD standards and provide practical guides of how the measuring works in industrial workstations.



Increasing productivity with proper ergonomics

This informational e-book will help you learn how ergonomic environments can have a direct influence on employee well-being, the reduction of time and waste, and ultimately, greater productivity.

These and more educative and useful e-books available on our website:

treston.com/catalogues-and-brochures



Product animations, informational videos and more!

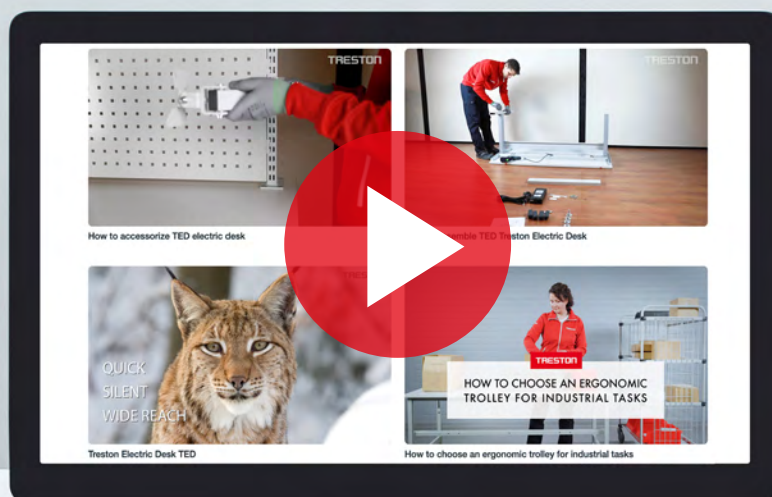

vimeo.com/trestongroup

What our customers say



"Several competitor products we viewed didn't give us the same level of confidence, modularity and robustness"

– David Walch, Operations Director,
FT Technologies

STIEBEL ELTRON

"At Treston, we have found the solution with ESD-compliant and electrically height-adjustable tables."

– Jan Müller, Production Planner,
Stiebel Eltron

bol.com

"The two most important goals were ergonomics and efficiency. This we have reached by using Treston."

– Lisanne Broer-van Abeelen,
bol.com fulfilment center



"Thank you for the informative day at Treston. Your great team impressed me with their knowledge."

– M. Huber, Kaiserslautern,
SKS Welding Systems GmbH



"The new furniture has significantly improved ergonomics, occupational health, and job satisfaction."

– Hannu Pesonen,
Development Manager, Jotwire

Read all our customer stories at:

[treston.com/about-us/
customer-stories](https://treston.com/about-us/customer-stories)

HEADQUARTERS

Treston Oy
Sorakatu 1
FI-20730 Turku
Tel. +358 10 4469 11
Fax +358 10 4469 789
sales@treston.com
www.treston.com

FACTORIES

Treston Oy, Turku plant
Sorakatu 1
FI-20730 Turku
Tel. +358 10 4469 11
Fax +358 10 4469 789
sales@treston.com
www.treston.fi

Treston Oy, Jyväskylä plant
PO Box 33 (Sohlberginkatu 10)
FI-40351 Jyväskylä
Tel. +358 10 4469 11
Fax +358 10 4469 290
sales@treston.com
www.treston.fi

FRANCE

Treston France SARL
Z.A.C. de la Bonne Rencontre
1, voie Gallo Romaine, Quincy-Voisins
77334 Meaux Cedex
Tel. +33 1 64 17 11 11
Fax +33 1 64 17 11 10
infofr@treston.com
www.treston.fr

GERMANY

Treston Deutschland GmbH
Friedrich-Ebert-Damm 143
22047 Hamburg
Tel. +49 40 8816 5022 - 0
Fax +49 40 8816 5022 - 10
info.de@treston.com
www.treston.de

Treston Deutschland GmbH
Niederlassung Raunheim
Frankfurter Straße 101
65479 Raunheim
Tel. +49 6142 992 50
Fax +49 6142 9925-29
mail.de@treston.com
www.treston.de

SWEDEN

Treston AB
Enhagslingen 6
187 40 Täby
Tel. +46 8 511 791 60
Fax +46 8 511 797 60
info.se@treston.com
www.treston.se

UNITED KINGDOM

Treston Ltd
Treston House
5b Bone Lane, Newbury
Berkshire, RG14 5SH
Tel. +44 1635 521521
Fax +44 1635 37452
salesuk@treston.com
www.treston.com

USA

Treston, Inc.
156 Bluffs Court
Canton, GA 30114
Tel. +1 770-721-7980
Fax +1 770-720-6584
infousa@treston.com
www.treston.us

Premium partners

BENELUX

Human Workspace BV
Mechelaarstraat 17
4903 RE Oosterhout
Tel. +31 162 454 383
sales@humanworkspace.nl
www.humanworkspace.nl

NORWAY

Industrimøbler AS
Bjørnerudveien 12A
1266 Oslo
Tel. +47 22 25 05 00
post@industrimobler.no
www.industrimobler.no

TRESTON

Workspaces for happier workfaces.

This is our aspiration. This is our promise. This is what Treston is all about.

With decades of experience, in-depth understanding of ergonomics in industrial environments, unmatched ESD competence and proven LEAN knowhow we at Treston are in a unique position to help our customers in keeping their business and people in good shape.

treston.com